

Magnetic Displacement Sensors

HMC1501/1512

The Honeywell HMC1501 and HMC1512 are miniature surface mount sensors for linear, angular, or rotary displacement designed for magnetic saturating field sensing. The HMC1501 contains a single saturated-mode Wheatstone bridge sense element that creates an output voltage with respect to the direction of the magnetic flux passing over the sensor surface. The HMC1512 contains dual saturated-mode Wheatstone bridge elements co-located to provide an extended range of angular displacements. Both sensor types are cost effective and space-efficient solutions for high-volume OEM designs. Applications for the HMC15xx sensors include Position Sensing, Rotary speed and angle detection, and non-contact precision location measurement systems.

The HMC15xx sensors utilize Honeywell's Anisotropic Magnetostrictive (AMR) technology that provides advantages over hall-effect based magnetic sensors. They are able to resolve better than tenths of a degree or tenths of millimeters, withstand large variations in magnet-to-sensor gaps, and exhibit insensitivity to shocks and vibrations. Honeywell's Magnetic Sensors are among the most precise and reliable position sensors in the industry. Honeywell continues to maintain product excellence and performance by introducing innovative solid-state magnetic sensor solutions. These are highly reliable, top-performance products that are delivered when promised. Honeywell's magnetic sensor provide real solutions you can count on.

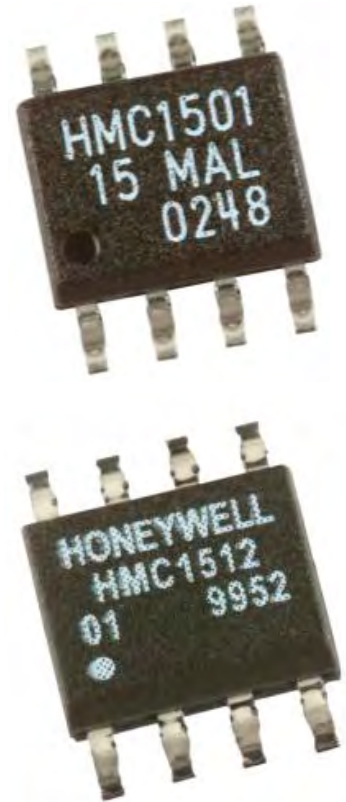

FEATURES

- Wide Angular Range

- Effective Linear Range

- Absolute Sensing

- Low Cost

- Available in Tape & Reel Packaging

- 4-Element Wheatstone Bridges

- Surface Mount Sensors

- Low Voltage Operations (2.0V)

BENEFITS

- HMC1501 – Angular range of $\pm 45^\circ$ with $< 0.07^\circ$ resolution
- HMC1512 – Angular range of $\pm 90^\circ$ with $< 0.05^\circ$ resolution

- $> 8\text{mm}$ when two sensors are mounted on two ends. Additional range can be added through multiple sensor arrays

- No indexing with exact position known

- Designed for High Volume, Cost Effective OEM Designs

- High Volume OEM Assembly

- Low Noise Passive Element Design

- RoHS Compatible and suitable for High Speed SMT Assembly

- Compatible for Battery Powered Applications

HMC1501/1512 Technical Specifications

CHARACTERISTICS	CONDITIONS*	MIN	TYP	MAX	UNITS
HMC1501 BRIDGE ELEMENT					
SUPPLY	V _{bridge} (V _b) referenced to GND	1.0	5.0	25	Volts
RESISTANCE	Bridge current = 1mA	4000	5000	6500	ohms
ANGLE RANGE	>Saturation Field	-45		+45	deg
SENSITIVITY	V _b =5 volts, field=800e @ zero crossing @ zero crossing averaged in a 45° range		2.1		mV/°
			1.8		mV/°
OUTPUT VOLTAGE	V _b =5 volts, field=80 Oe	100	120	140	mVpp
BRIDGE OFFSET	field=80 Oe	-7	3	+7	mV/V
RESOLUTION	BW=10Hz, V _b =5 volts		0.07		deg
NOISE DENSITY	@1Hz, V _b =5 volts		100		nV/sqrt Hz
HMC1512 BRIDGE ELEMENTS					
SUPPLY	V _{bridge} (V _b) referenced to GND	1.0	5.0	25	Volts
RESISTANCE	Bridge current = 1mA	2000	2100	2800	ohms
ANGLE RANGE	>Saturation Field	-90		+90	deg
SENSITIVITY	V _b =5 volts, field=800e @ zero crossing @ zero crossing averaged in a 45° range		2.1		mV/°
			1.8		mV/°
OUTPUT VOLTAGE	V _b =5 volts, field=80 Oe	100	120	140	mVpp
BRIDGE OFFSET	field=80 Oe				
	Bridge A	-7	0	+7	mV/V
	Bridge B	-7	0	+7	mV/V
RESOLUTION	BW=10Hz, V _b =5 volts		0.05		deg
NOISE DENSITY	@1Hz, V _b =5 volts		70		nV/sqrt Hz
COMMON					
OPERATING TEMPERATURE	Ambient	-40		+125	°C
STORAGE TEMPERATURE	Ambient, unbiased	-55		+150	°C
HUMIDITY	Tested at 85°C			85	%
HYSTERESIS ERROR	Field > 80 Oe, V _b =5 volts		30		μV
			0.017		deg
BRIDGE OHMIC TEMPCO	V _b =5 volts, T _A = -40 to +125°C		2800		ppm/°C
SENSITIVITY TEMPCO	V _b =5 volts, T _A = -40 to +125°C		-3200		ppm/°C
BRIDGE OFFSET TEMPCO	T _A = -40 to +125°C		±100		ppm/°C

* Tested at 25°C except stated otherwise.

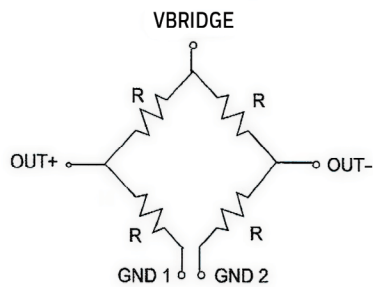

HMC1501

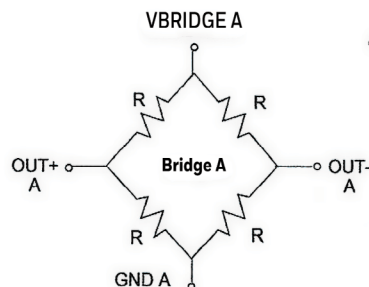

HMC1512

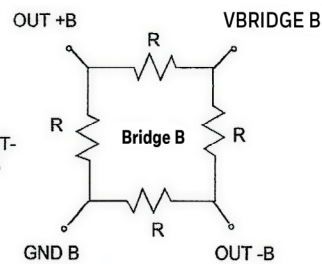

Pin Configurations

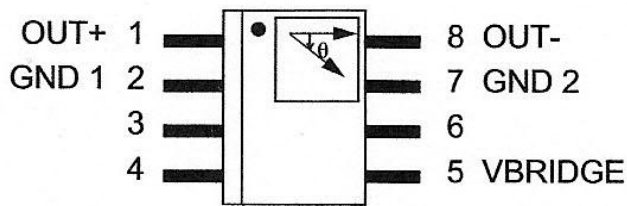

HMC1501

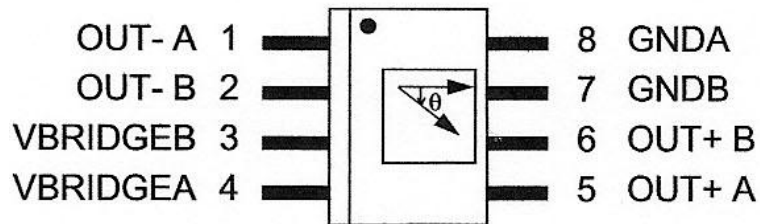

HMC1512

Package Outline

PACKAGE DRAWING HMC1501/HMC1512 (8-PIN SOIC, dimensions in millimeters)

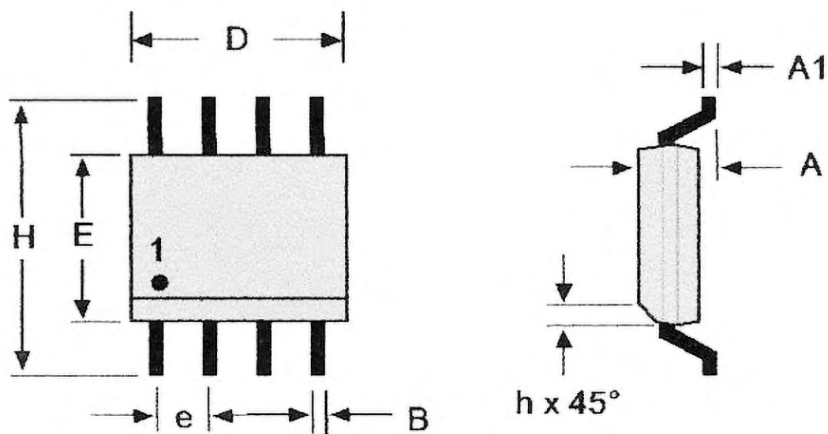

	MILLIMETERS		INCHES	
	Min	Max	Min	Max
A	1.371	1.728	0.054	0.068
A1	0.101	0.249	0.004	0.010
B	0.355	0.483	0.014	0.019
D	4.800	4.979	0.189	0.196
E	3.810	3.988	0.150	0.157
e	1.270 ref		0.050 ref	
H	5.816	6.198	0.229	0.244
h	0.381	0.762	0.015	0.030

Magnetic Mounting Considerations

The HMC1501 has an internal sensor die placed toward the forward edge, between pins 1 and 8, to make linear translation applications more convenient. The figure below indicates this location.

The HMC1512 has two sensor bridges optimized for rotary translation applications. Thus the die is centered in all three dimensions within the SOIC-8 package. The figure below indicates location.

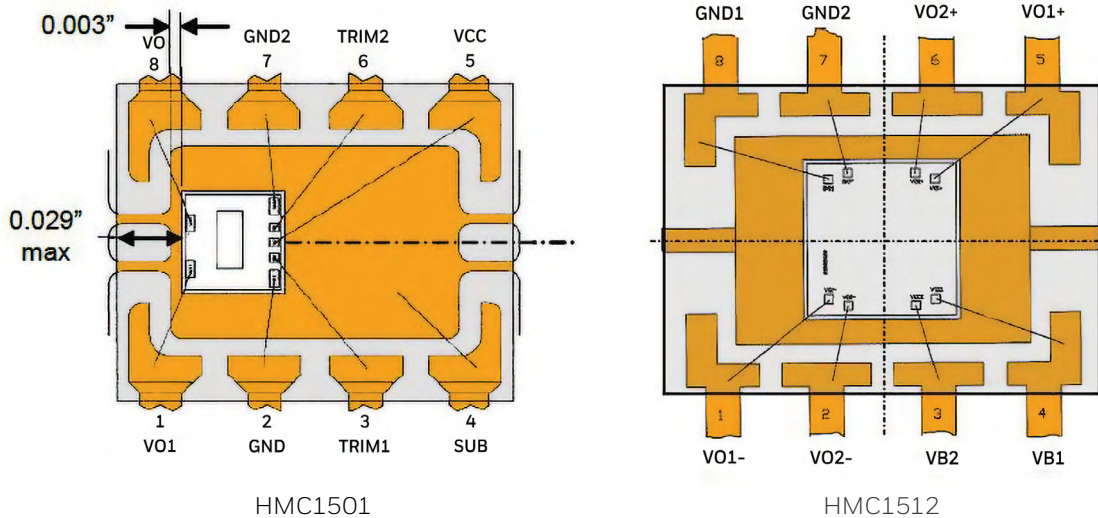

Basic Device Operation

The Honeywell HMC15xx magnetoresistive sensors are Wheatstone bridges to measure magnetic field direction. The bridge elements change their resistance when a magnetic field is applied across the silicon die with the thin films of magneto-resistive ferrous material forming the resistive elements. The magnetoresistance is a function of $\cos^2 \theta$, where θ is the angle between the applied magnetic field (M) and the current flow direction in the thin film.

When the applied magnetic field becomes moderate (50 Oersted or larger), the magnetization of the thin films align in the same direction as the applied field; and becomes the saturation mode. In this mode, is the angle between the direction of the applied field and the bridge current flow, and the magnetoresistive sensor is only sensitive to the direction of the applied field (not amplitude).

The sensor is in the form of a Wheatstone bridge (see figures below). The resistance (R) of all four bridge legs is the same. The bridge power supply V_b or V_{bridge} , causes current to flow through the bridge elements as indicated in the figures.

Both the HMC1501 and HMC1512 are designed to be used in saturation mode, with applied fields of 80 Oersteds or greater, required to meet the specifications in this datasheet.

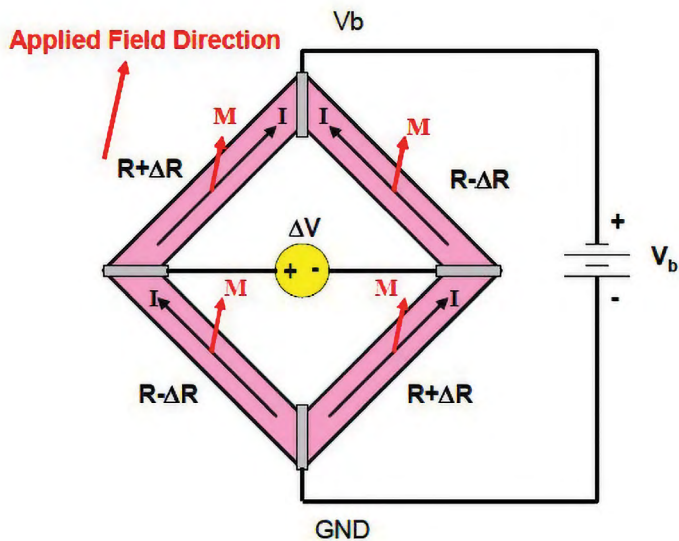

The HMC1501 contains one bridge and the HMC1512 has two identical bridges, coexisting on a single die. Bridge B is physically rotated 45° from bridge A. The HMC1501 has a sensor output of $\Delta V = -V_b \cdot S \sin(2\theta)$, and the HMC1512 has a sensor output of $\Delta V = V_b \cdot S \sin(2\theta)$ for sensor A and sensor B's output is $\Delta V = -V_b \cdot S \cos(2\theta)$. V_b is the supply voltage, and S is a sensor constant determined by the materials. For these Honeywell sensors, S is typically 12mV/V.

Application Notes

The HMC1501 and HMC1512 are Honeywell's AMR based magnetic position sensors that contain AMR sensor bridges to be used in saturation mode. The HMC1501 contains one AMR bridge for a $\pm 45^\circ$ range of position sensing, and the HMC1512 contains two AMR bridges for a $\pm 90^\circ$ range of position sensing. The bridge differential output voltage (V) for the HMC1501 is:

$\Delta V = -V_s S \sin(2\theta)$ where:

V_s = Supply Voltage (volts)

S = Material Constant (12mV/V)

θ = Reference to Magnetic Field Angle (degrees)

With the bridges on the HMC1512 oriented 45° in rotation from each other, the differential output voltage for sensor bridge A is:

$$\Delta V_A = V_s S \sin(2\theta)$$

And for sensor bridge B, the differential output voltage is:

$$\Delta V_B = -V_s S \cos(2\theta)$$

Using the HMC1512 bridge A signal output plotted versus theta, the figure below depicts the two-cycle waveform.

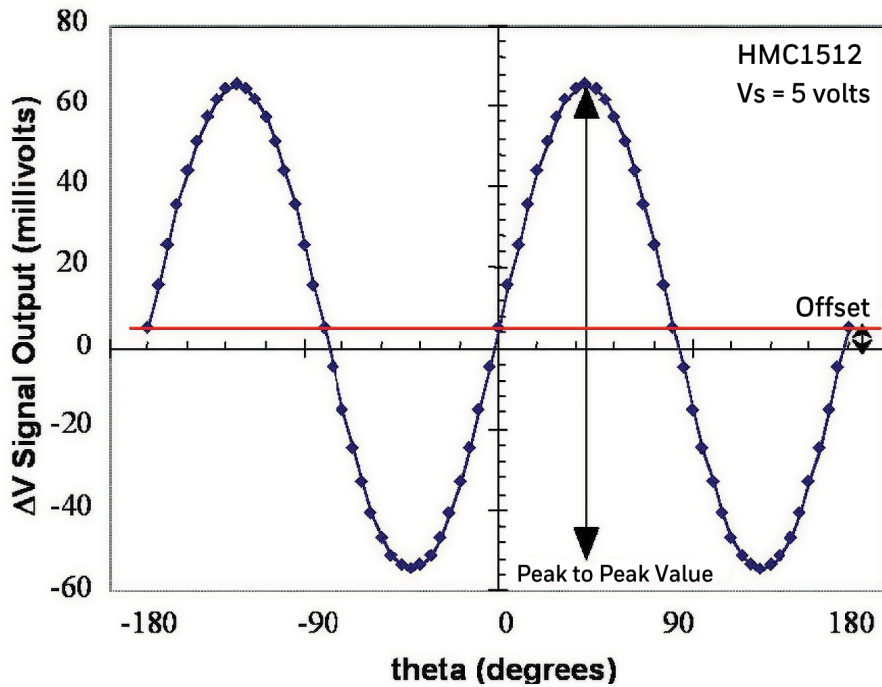

As you can see above, the most linear range for this sensor bridge is in the $\pm 45^\circ$ range about the -180 , -90 , 0 , 90 , and 180 degree points. Of these the 0 and 180 points have a positive slope, and the ± 90 points have a negative slope. These slopes can be taken to full advantage for angular and linear positioning applications.

Basic Position Sensing

For simple magnetic position sensing, the HMC1501 sensor can be used to detect the relative motion of a nearby magnet in linear or angular displacement.

With the orientation of the stationary HMC1501, the magnet position can translate to $\pm 45^\circ$ and stay within a linear slope of ΔV versus θ for position sensing. Given a typical supply voltage of 5 volts ($V_s = +5V_{dc}$), the HMC1501 will provide about a 120 millivolt swing (± 60 millivolts) on 2.5 volt bias voltage. The reason for the 2.5 volts is that with the Wheatstone bridge provides a differential voltage output with a bias voltage from the 5 volt supply voltage. The figures show the mechanical orientation and the electrical transfer function.

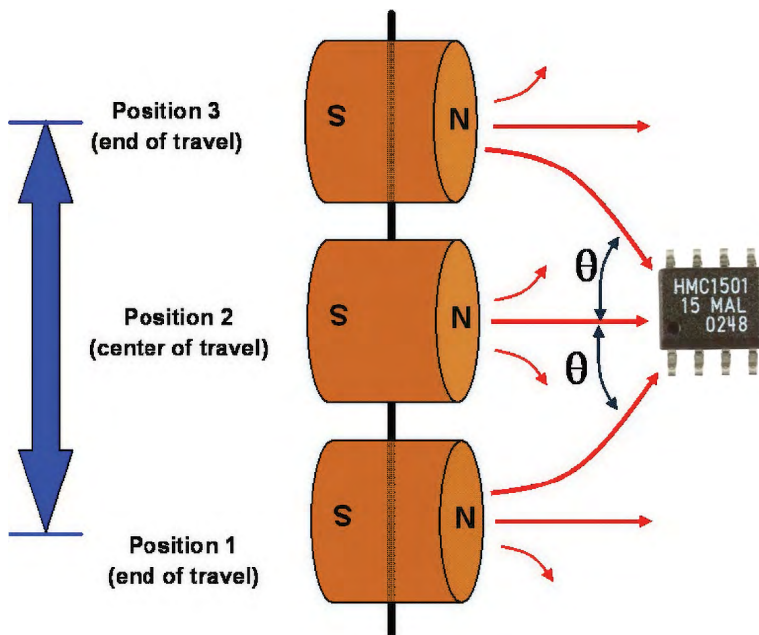

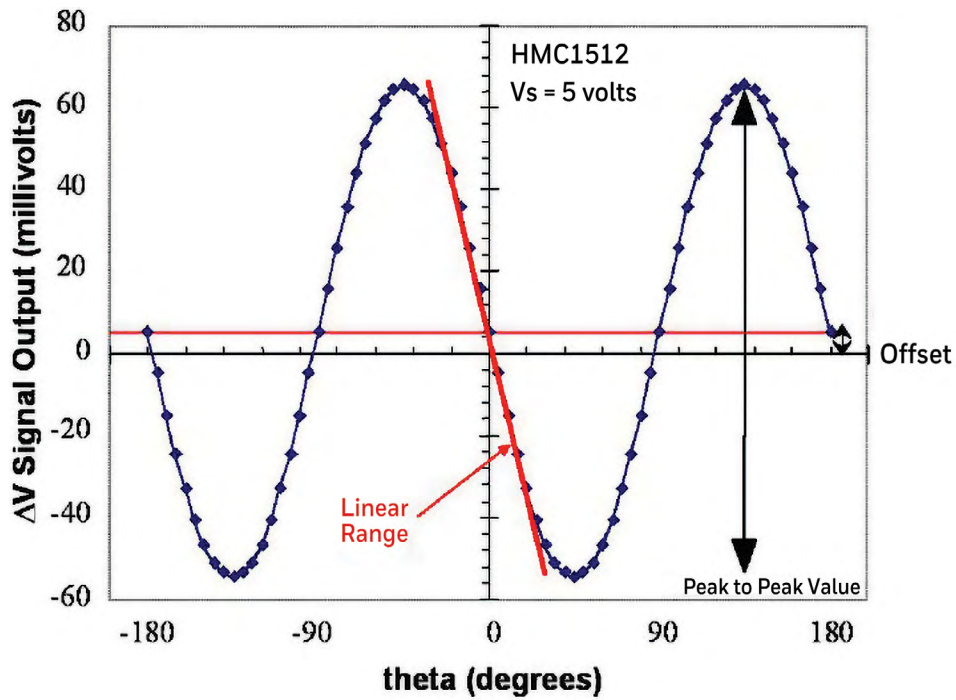

To interface with output pins of the HMC1501 (OUT+, OUT-), an instrumentation amplifier circuit is typically used.

Instrumentation amplifiers can be purchased as complete integrated circuits, or constructed via combinations of discrete components and integrated circuits; such as operational amplifiers (op-amps). The purpose of an instrumentation amplifier is to derive the difference signal (OUT+ minus OUT-), and to provide additional signal amplification as desired. The figure below shows a typical instrumentation amplifier circuit using an op-amp with external discrete components.

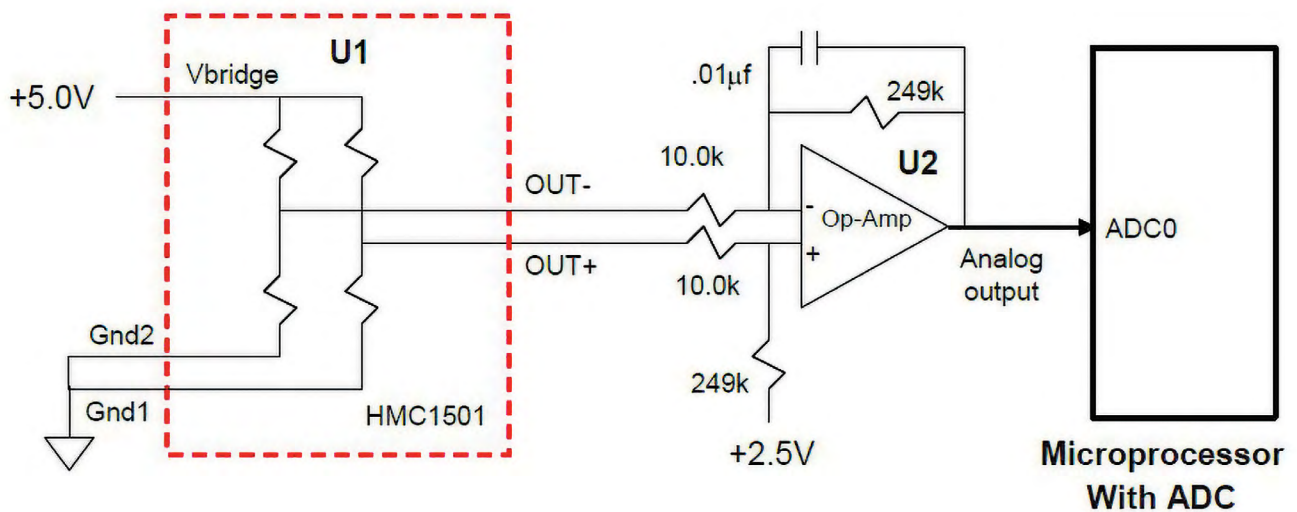

With a typical HMC1501 position sensor, a low-cost operational amplifier (e.g. LMV358) could be used as a differential amplifier shown in the schematic above. The 10 kilo-ohm input resistors present a high impedance from the Wheatstone bridge, and the 249 kilo-ohm resistor set the amplifier gain and bias at 25V/V and 2.5 volts respectively. The 0.01 microfarad capacitor is placed in the feedback loop to low system bandwidth and to further exclude noise outside the sensor and amplifier circuits. The analog output voltage of the amplifier is typically fed to an Analog-to-Digital Converter (ADC) stage stand-alone or within a microprocessor integrated circuit. A recommendation of 10-bit ADC circuits or higher is expected.

For angular measurements, the same information applies, except the mechanical arrangement changes a bit.

The application circuits herein constitute typical usage and interface of Honeywell product. Honeywell does not warranty or assume liability of customerdesigned circuits derived from this description or depiction.

Honeywell reserves the right to make changes to improve reliability, function, or design. Honeywell does not assume any liability arising out of the application or use of any product or circuit described herein; neither does it convey any license under its patent rights nor the rights of others.

U.S. Patents 4,441,072, 4,533,872, 4,569,742, 4,681,812, 4,847,584 6,529,114 and 7,095,226 apply to the technology described.

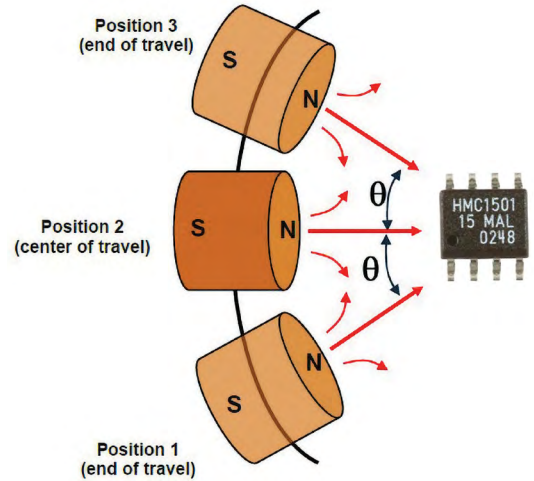

ORDERING INFORMATION

Ordering Number	Product
HMC1501	Magnetic Sensor
HMC1501-TR	Tape and Reel with 1k units/reel
HMC1512	Magnetic Sensor
HMC1512-TR	Tape and Reel with 1k units/reel



Caution

This part is sensitive to damage by electrostatic discharge. Use ESD precautionary procedures when touching, removing or inserting.

CAUTION: ESDS CAT. 1B

For more information

For more applications information, see application note AN211 on the magneticsensors.com website or contact us at 800-323-8295.

Honeywell Aerospace

12001 State Highway 55
Plymouth, MN 55441
aerospace.honeywell.com

#900246 Rev D

N61-2042-000-000 | 03/19
© 2019 Honeywell International Inc.

Honeywell