

GENERAL PRESSURE TRANSDUCERS GPT SERIES-II



Honeywell

GENERAL PRESSURE TRANSDUCERS

DESCRIPTION

Honeywell's GPT Series-II Pressure Transducers use piezoresistive sensing technology with ASIC (Application Specific Integrated Circuit) signal conditioning in a cupreous housing with electrical connector. The GPT Series-II provides a cost-competitive solution for wide-ranging potential applications in tough environments, and also has flexible configurations for customer's requests such as connector pin definition, port type, etc.

DIFFERENTIATION & VALUE TO CUSTOMERS

- **Super EMC & dielectric & insulation capability**
 - Operate reliably in the presence of electromagnetic fields, such as near wireless signals, RF communication, and electrical devices.
- **Multiple connector & port types**
 - Multiple options of connector & port types is available, which will widely support different customer requests of broad break-down market and applications.
- **Flexible configurations**
 - Flexible configuration for connector pin definition, which make it possible that we could fast respond to customers for different pin definition requests.
- **Local R&D center & fast technical support**
 - Local R&D center could offer more real-time response to customers, which make the technical support at fingertips to customers.
- **Local manufacturing & world-class factory**
 - Local manufacturing offer more tighter lead time, world-class factory contribute high quality delivery, which means better supply chain to customers.

FEATURES AND BENEFITS

FEATURES

- Pressure range: 10 bar to 80 bar
- Operating Temperature Range: -40°C ~125°C
- Multiple electrical connector options for customers
- Output: Regulated 4-20mA , Ratiometric
- Fully calibrated and temperature compensated
- Total Error Band: $\pm 1.5\%$ FSS from -25 °C to 100 °C
- EMC: Heavy Industrial Level for 4-20mA& Ratiometric version and vehicle Level for Regulated version
- Ingress protection up to IP67
- Response time: <2 ms
- RoHS, REACH, and CE compliant

POTENTIAL APPLICATIONS

- Heavy vehicle off-road
- Machinery and trucks
- Rubber process machinery
- Plastics process machinery
- Water pumps
- Packaging machinery
- Textile machinery
- CNC machine
- Material process machinery

PORTFOLIO

Honeywell's GPT Series-II joins GPT Series heavy duty pressure transducers.

GPT SERIES-II

TABLE 1 . ELECTRICAL SPECIFICATIONS (AT 25°C UNLESS OTHERWISE NOTED.)

| Characteristic | Parameter | | |
|--------------------------|--------------|------------|---------|
| Output | 10%-90%Vs | 0.5-4.5Vdc | 4-20mA |
| Supply Voltage | 4.75-5.25Vdc | 8-32V | 8-32V |
| Over and reverse Voltage | ±30 Vdc | ±36 Vdc | ±36 Vdc |

Table 2 . PERFORMANCE SPECIFICATIONS (AT 25°C UNLESS OTHERWISE NOTED.)

| Characteristic | Parameter |
|------------------------------------------|-------------------------------------------------------------------|
| Operating temperature range ¹ | -40°C to 125°C |
| Storage temperature range | -40°C to 125°C |
| Accuracy BFSL ² | ±0.5 %FSS |
| Total Error Band ³ | ±1.5 %FSS (-25°C to 85°C) ±2%FSS (-40°C to 100°C) ⁵ |
| Response time | 2 ms (10% to 90% step change in pressure) |
| Turn on time | <7ms |
| EMC rating | refer to table 3 |
| Long term stability (1000 hr, 25°C) | ±0.5 %FSS |
| Insulation resistance | >100MOhm,500VDC |
| Dielectric strength | >1500VAC, 1min |
| Load resistance | Voltage output: 2k ohm min; Current Output: (Vs-8)*50 ohm max |
| Life ⁴ | >10 million full scale pressure cycles |

¹ Dependent on external and internal seal. See Table 6 for relationship between temperature range and pressure range and media details

²**Accuracy:** The maximum deviation in output from a Best Fit Straight Line (BFSL) fitted to the output measured over the pressure range at 25 °C. Includes all errors due to pressure non-linearity, pressure hysteresis, and pressure non-repeatability. See Figure 1.

³**Total Error Band:** The maximum deviation from the ideal transfer function over the entire compensated temperature and pressure range. Includes all errors due to offset, full scale span, pressure non-linearity, pressure hysteresis, pressure non-repeatability, thermal effect on offset, thermal effect on span, and thermal hysteresis. See Figure 1.

⁴**Life:** Test at 25 °C

⁵For internal seal material is FKM ±2%FSS (-25°C to 100°C)

GENERAL PRESSURE TRANSDUCERS

TABLE 3 . EMC RATING

| EMC RATING FOR INDUSTRIAL LEVEL ¹ | |
|----------------------------------------------------------------------------------------------------------|-------------------------------------------------------------------------------------------------------------------------------------------------------------------------------------|
| Electrostatic discharge | ±4 kV contact, ±8 kV air per IEC 61000-4-2 |
| Radiated immunity | 10 V/m (80 MHz to 1000 MHz) per IEC 61000-4-3 |
| Fast transient burst | ±2 kV per IEC 61000-4-4 |
| Surge Immunity | ±1 kV per IEC 61000-4-5 |
| Immunity to conducted disturbances | 3 V per IEC 61000-4-6 |
| Radiated emissions | 40 dB (30 MHz to 230 MHz), 47 dB (230 MHz to 1000 MHz) per CISPR 11:2009,A1:2010 |
| Radiated immunity | > 100V/m (200 to 2500 MHz) per ISO 11452-2 |
| EMC RATING FOR AUTOMOTIVE LEVEL ² | |
| Electrostatic discharge | power on mode: metal: ±8 kV contact; ±15 kV air non-metal: ±15 kV air Power off mode metal: ±8 kV contact; ±15 kV air non-metal: ±15 kV air pin: ±6 kV ISO10605-2008 |
| Absorber-lined shielded enclosure | 75V/m 80MHz~3000MHz Horizontal & Vertical ISO11452-2 |
| Radio disturbance characteristics | 0.15-108MHz Class 3 GB/T18655-2018 |
| Bulk current injection | 75mA CW+AM ISO11452-4 |
| Electrical transient conduction along supply lines only | 1,2,3,4,5B ISO7637-2 |
| Electrical transient transmission by capacitive and inductive coupling via lines other than supply lines | CCC ±56V DCC ±35V DCC -45V ISO7637-3 |

¹ EMC rating for Industrial Level for Ratiometric and current circuit.

² EMC rating for Automotive Level for regulated circuit.

GENERAL PRESSURE TRANSDUCERS

TABLE 4. PRESSURE REFERENCE DEFINITIONS

| Pressure Reference | Definition |
|--------------------|-------------------------------------------------------------------------------------------------------------------------------------------------------------------|
| Absolute | Absolute The output is calibrated to be proportional to the difference between applied pressure and a fixed reference to perfect vacuum (absolute zero pressure). |
| Sealed gage | The output is calibrated to be proportional to the difference between applied pressure and a reference of 1 standard atmosphere (1.013 bar A). |

TABLE 5 . PRESSURE RATINGS

| Operating Pressure | Overpressure ¹ | Burst Pressure ² |
|--------------------|---------------------------|-----------------------------|
| 10 to 20 bar | 60bar | 100bar |
| 40 to 100 bar | 240bar | 400bar |

¹Overpressure: The maximum pressure which may safely be applied to the product for it to remain in specification once pressure is returned to the operating pressure range. Exposure to higher pressures may cause permanent damage to the product.

²Burst Pressure: The maximum pressure which may be applied without causing escape of pressure media. The product should not be expected to function after exposure to the burst pressure.

TABLE 6 . SEAL RATINGS

| Internal Seal material | Operating temperature range | Typical Media ¹ |
|------------------------|-----------------------------|-----------------------------------------------|
| FVMQ | -40°C to 125°C | Dry air, Water |
| FKM | -25°C to 125°C | Engineer oil, Petroleum-based hydraulic fluid |

¹ Should not be used in refrigerant scenarios

GENERAL PRESSURE TRANSDUCERS

TABLE 7. ENVIRONMENTAL AND MECHANICAL SPECIFICATIONS

| Characteristic | Parameter | | | | | | | | | | | | | | | | | | | | | | | | |
|--------------------------------------|-----------------------------------------------------------------------------------------------------------------------------------------------------------------------------------------------------------------------------------------------------------------------------------------------------------------------------------------------------------------------------------------------------------------------------------------------------------------------------------------------------------------------------------------------|----------|-------------------------|-------------------------|-----------|--------|----|-----|------|----|-----|------|----|-----|-------|----|----|-----|------|----|-----|------|----|-----|-------|
| Vibration | GB/T28046.3-2011 | | | | | | | | | | | | | | | | | | | | | | | | |
| | 表 16 最大加速度和频率 ($f_n \geq 40\text{Hz}$) | | | | | | | | | | | | | | | | | | | | | | | | |
| | <table border="1"> <thead> <tr> <th>车辆平面方向</th> <th>频率 Hz</th> <th>最大加速度 m/s^2</th> <th>循环数 (近似值)</th> </tr> </thead> <tbody> <tr> <td rowspan="3">纵向, 横向</td> <td>35</td> <td>150</td> <td>2800</td> </tr> <tr> <td>35</td> <td>120</td> <td>7000</td> </tr> <tr> <td>35</td> <td>100</td> <td>21000</td> </tr> <tr> <td rowspan="3">垂直</td> <td>35</td> <td>300</td> <td>2800</td> </tr> <tr> <td>35</td> <td>250</td> <td>7000</td> </tr> <tr> <td>35</td> <td>200</td> <td>21000</td> </tr> </tbody> </table> | 车辆平面方向 | 频率 Hz | 最大加速度 m/s^2 | 循环数 (近似值) | 纵向, 横向 | 35 | 150 | 2800 | 35 | 120 | 7000 | 35 | 100 | 21000 | 垂直 | 35 | 300 | 2800 | 35 | 250 | 7000 | 35 | 200 | 21000 |
| | 车辆平面方向 | 频率 Hz | 最大加速度 m/s^2 | 循环数 (近似值) | | | | | | | | | | | | | | | | | | | | | |
| | 纵向, 横向 | 35 | 150 | 2800 | | | | | | | | | | | | | | | | | | | | | |
| | | 35 | 120 | 7000 | | | | | | | | | | | | | | | | | | | | | |
| | | 35 | 100 | 21000 | | | | | | | | | | | | | | | | | | | | | |
| 垂直 | 35 | 300 | 2800 | | | | | | | | | | | | | | | | | | | | | | |
| | 35 | 250 | 7000 | | | | | | | | | | | | | | | | | | | | | | |
| | 35 | 200 | 21000 | | | | | | | | | | | | | | | | | | | | | | |
| Shock | 100 G per MIL-STD-202G, Method 213B, Cond. C | | | | | | | | | | | | | | | | | | | | | | | | |
| Ingress protection | IP67 | | | | | | | | | | | | | | | | | | | | | | | | |
| Humidity | 0 %RH to 95 %RH, non-condensing | | | | | | | | | | | | | | | | | | | | | | | | |
| Wetted materials | Port: SS303; Aluminum Gasket: NBR(-25-125°C); FVMQ : (-40-125°C); EPDM : (-40-125°C) | | | | | | | | | | | | | | | | | | | | | | | | |
| External materials housing connector | SS303; Aluminum | | | | | | | | | | | | | | | | | | | | | | | | |
| Connector | PBT 30% GF | | | | | | | | | | | | | | | | | | | | | | | | |

GENERAL PRESSURE TRANSDUCERS

FIGURE 1. NOMENCLATURE AND ORDER GUIDE

For example, **GPTAN1NC010BSAAX** defines an GPT Series-II Heavy Duty Pressure Transducer, Metri-Pack 150 electrical connector type, 1/4-18 NPT pressure port type, 10 bar pressure range, sealed gage pressure reference, ratiometric: 5 Vs, 10% to 90% Vs output transfer function

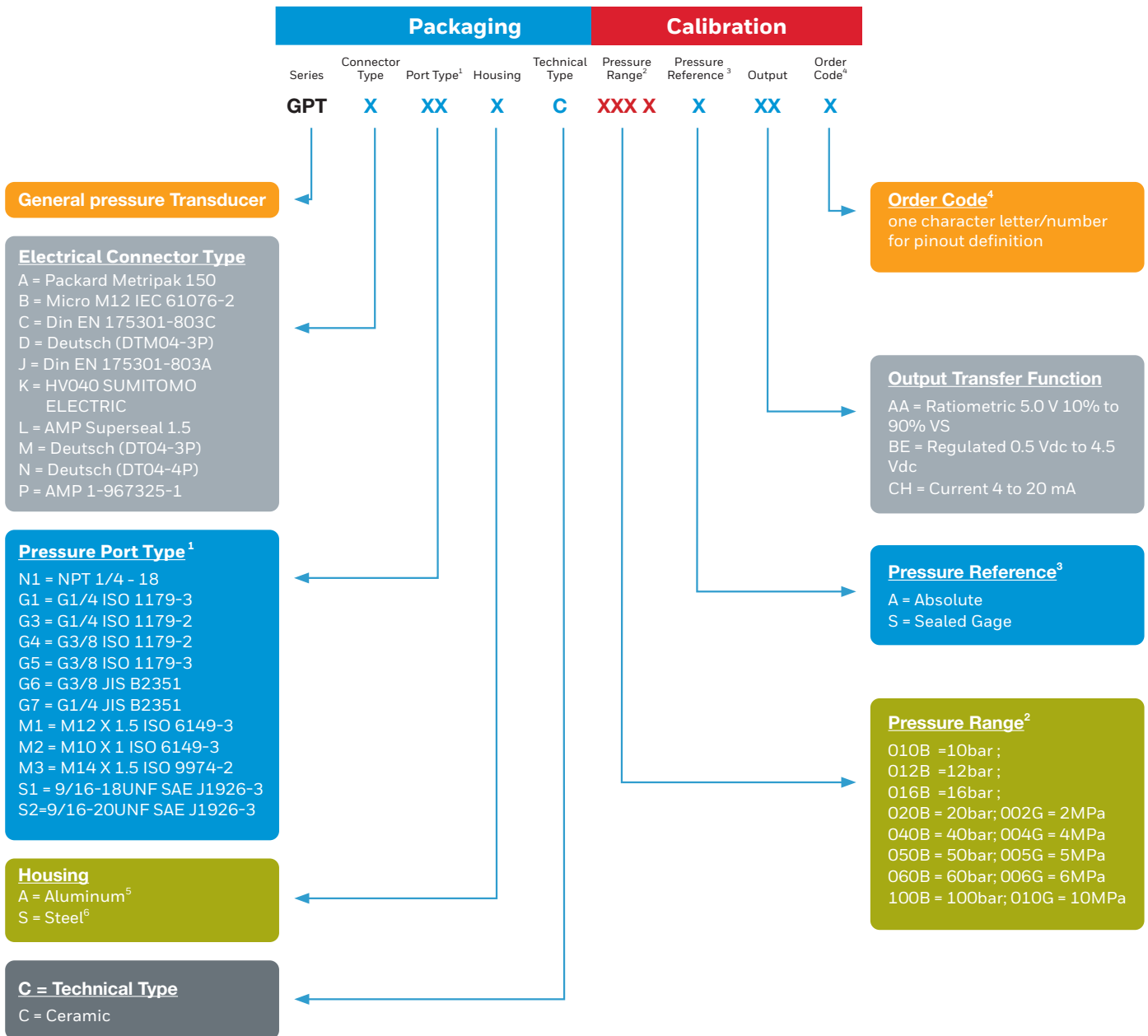

¹ Contact Honeywell Sales for custom configurations.
² Contact Honeywell Sales for custom configuration
³ Sealed gage option only available in pressure ranges at or above 20 bar.
⁴ Contact Honeywell Sales for custom configurations.
⁵ For more than 20Bar.only configure with S (steel housing).
⁶ For Aluminum port .NO configure with N type Port.

GPT SERIES-II

FIGURE 2. ELECTRICAL CONNECTOR PIN DEFINITION

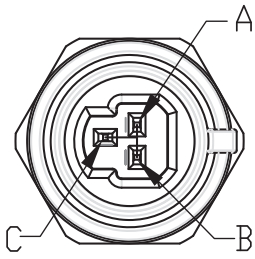
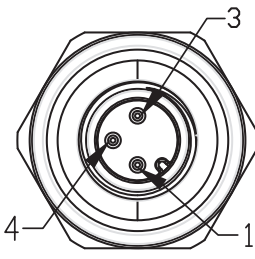
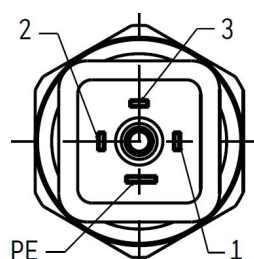
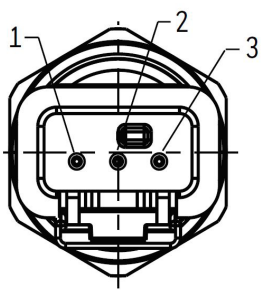
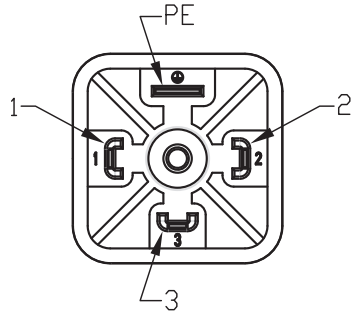
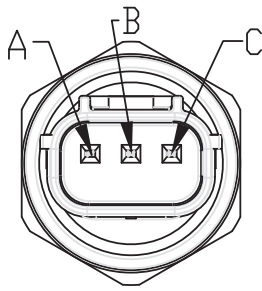
| A = Packard Metripak 150 | | | B = Micro M12 IEC 61076-2 | | | C = Din EN 175301-803C | | |
|-------------------------------------------------------------------------------------|----------------|----------------|-------------------------------------------------------------------------------------|----------------|----------------|---------------------------------------------------------------------------------------|----------------|----------------|
| PIN NO | Voltage Output | Current Output | PIN NO | Voltage Output | Current Output | PIN NO | Voltage Output | Current Output |
| A | GND | RTN | 1 | Vs | Vs | 1 | GND | RTN |
| B | Vs | Vs | 3 | GND | RTN | 2 | Vs | Vs |
| C | Vout | NC | 4 | Vout | NC | 3 | Vout | NC |
| | | | | | | PE | NC | NC |
| Standard | | | Standard | | | Standard | | |
|  | | |  | | |  | | |
| D = Deutsch (DTM04-3P) | | | J = Din EN 175301-803A | | | K = HV040 SUMITOMO ELECTRIC | | |
| PIN NO | Voltage Output | Current Output | PIN NO | Voltage Output | Current Output | PIN NO | Voltage Output | Current Output |
| 1 | GND | RTN | 1 | Vs | Vs | A | Vs | Vs |
| 2 | Vout | NC | 2 | GND | RTN | B | GND | RTN |
| 3 | Vs | Vs | 3 | Vout | NC | C | Vout | NC |
| | | | PE | NC | NC | | | |
| Standard | | | Standard | | | Standard | | |
|  | | |  | | |  | | |

GENERAL PRESSURE TRANSDUCERS

| L = AMP Superseal 1.5 | | | M = Deutsch (DT04-3P) | | | N = Deutsch (DT04-4P) | | | P = AMP 1-967325-1 | | |
|-----------------------|----------------|----------------|-----------------------|----------------|----------------|-----------------------|----------------|----------------|--------------------|----------------|----------------|
| PIN NO | Voltage Output | Current Output | PIN NO | Voltage Output | Current Output | PIN NO | Voltage Output | Current Output | PIN NO | Voltage Output | Current Output |
| 1 | Vs | Vs | A | Vs | Vs | 1 | GND | RTN | 1 | Vs | Vs |
| 2 | GND | RTN | B | GND | RTN | 2 | Vs | Vs | 2 | GND | RTN |
| 3 | Vout | NC | C | Vout | NC | 3 | NC | NC | 3 | Vout | NC |
| | | | | | | 4 | Vout | NC | 4 | NC | NC |
| Standard | | | Standard | | | Standard | | | Standard | | |

FIGURE 3. PRODUCT OUTLINE DIMENSIONS (FOR REFERENCE ONLY)

For example, the image of **GPTAN1NC010BSAAX** is shown as below, which defines a Pressure Transducer with Metri-Pack 150 connector and 1/4-18 NPT port, more product-outline-dimension information is shown in the table6 and table7.

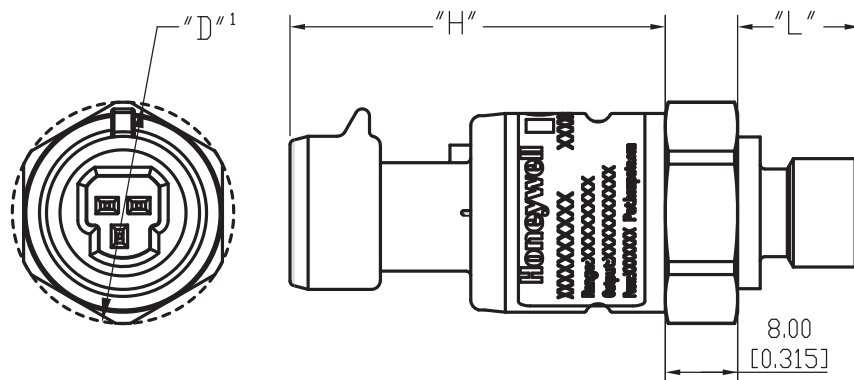

¹ Dimension "D" is defined as the maximum rotating diameter of product radial outline profile, it corresponds to the customer's design for minimum installation space.

GPT SERIES-II

TABLE 6. OUTLINE DIMENTION FOR DIFFERENT CONNECTORS

| Electrical Connector Type | H (MM/[IN]) | D (MM/[IN]) |
|-----------------------------|---------------|--------------|
| A = Packard Metripak 150 | 41.55/[1.636] | 24/[0.945] |
| B = Micro M12 IEC 61076-2 | 36.05/[1.419] | 22/[0.866] |
| C = Din EN 175301-803C | 31.75/[1.250] | 24/[0.945] |
| D = DTM04-3P | 46.75/[1.841] | 24/[0.945] |
| J = Din EN 175301-803A | 31.05/[1.222] | 40/[1.575] |
| K = HV040 SUMITOMO ELECTRIC | 40.65/[1.600] | 22/[0.866] |
| L = AMP Superseal 1.5 | 46.55/[1.833] | 26/[1.024] |
| M = DT 04-3P | 49.00/[1.930] | 26/[1.024] |
| N = DT 04-4P | 49.00/[1.930] | 24.5/[0.965] |
| P = AMP 1-967325-1 | 42.55/[1.675] | 26/[1.024] |

TABLE 7. OUTLINE DIMENTION FOR DIFFERENT PORTS

| Pressure Port Type | L (MM/[IN]) |
|------------------------------|---------------|
| G1 = G1/4 ISO 1179-3 | 11.30/[0.445] |
| G3 = G1/4 ISO 1179-2 | 12.00/[0.472] |
| G6 = G3/8 JIS B2351 | 12.20/[0.480] |
| G7 = G1/4 JIS B2351 | 14.00/[0.551] |
| M1 = M12 X 1.5 ISO 6149-3 | 13.50/[0.531] |
| N1 = NPT 1/4 - 18 | 15.00/[0.591] |
| S1 = 9/16-18 UNF SAE J1926-3 | 13.50/[0.531] |
| S2 = 7/16-20 UNF SAE J1926-3 | 12.50/[0.492] |

GPT SERIES-II

MOUNTING TORQUE

| | | |
|------------------------------------------------------------------------------------------------------------------------|-----------------------------------------------------------------------------------------------------------------------|----------------------------------------------------------------------------------------------------------------------|
| N1= 1/4-18 NPT | S2= 7/16-18UNF SAE J1926-3 | S2= 7/16-20UNF SAE J1926-3 |
| Seal: Pipe thread Mating Geometry: ANSI B1.20.1 Installation Torque ¹ : 2 to 3 Turns From FingerTight | Seal: O-ring ^{2,3} Mating Geometry: SAE J1926-1 Installation Torque ¹ :18 N m [12.3 ft lb] | Seal: O-ring ^{2,3} Mating Geometry: SAE J1926-1 Installation Torque ¹ :18 N m [12.3 ft lb] |
| M1=M12X1.5 ISO 6149-3 | M2=M10X1 ISO 6149-3 | M3=M14X1 ISO 9974-2 |
| Seal: O-ring ^{2,3} Mating Geometry: ISO 6149-1 Installation Torque ¹ : 25 N m [18.4 ft lb] | Seal: O-ring ^{2,3} Mating Geometry: ISO 6149-1 Installation Torque ¹ : 15 N m [11.04 ft lb] | Seal: O-ring ^{2,3} Mating Geometry: ISO 9974-2 Installation Torque ¹ : 50 N m [38.9 ft lb] |
| G1= G1/4 ISO1179-3 | G3= G1/4 JISB2351 | G4= G3/8 ISO1179-2 |
| Seal: Pipe thread Mating Geometry: ISO1179-3 Installation Torque ¹ : 50 N m [38.9 ft lb] | Seal: O-ring ^{2,3} Mating Geometry: JISB2351 Installation Torque ¹ : 50 N m [38.9 ft lb] | Seal: O-ring ^{2,3} Mating Geometry: ISO1179-2 Installation Torque ¹ : 50 N m [38.9 ft lb] |
| G5= G3/8 ISO1179-3 | G5= G3/8 ISO1179-3 | G5= G1/4 JISB2351 |
| Seal: O-ring ^{2,3} Mating Geometry: ISO 1179-3 Installation Torque ¹ : 50 N m [38.9 ft lb] | Seal: O-ring ^{2,3} Mating Geometry: 1179-3 Installation Torque ¹ : 50 N m [38.9 ft lb] | Seal: O-ring ^{2,3} Mating Geometry: JISB2351 Installation Torque ¹ : 50 N m [38.9 ft lb] |

¹Straight thread Maximum torque is validated 150% of installation torque

²Seals for port order codes G1,G3,G4,G5,M1,M2,M3,S1,S2 are included and assembled to the sensor

³O-ring and seal material is NBR -30°C to 125°C[-22°F to 257°F]

⁴Above Torque only for SUS303 housing.

⁵30N.m is Maximum for Aluminum housing.

Caution

PRODUCT DAMAGE

- Ensure torque specifications are determined for the specific application. Values provided are for reference only. (Mating materials and thread sealants can result in significantly different torque values from one application to the next.)
- When using mating parts made of stainless steel, use a thread sealant with anti-seize properties to prevent thread galling. Ensure the sealant is rated for the application.
- Use appropriate tools (such as an open ended wrench or deep well socket) to install transducers.
- Always hand-start transducers into the hole to prevent cross threading and damage.
- Ensure that torque is not applied to the electrical connector.
- Ensure that the proper mating electrical connector with a seal is used to connect the transducer. Improper or damaged seals can compromise ingress protection leading to short circuits.

Failure to comply with these instructions may result in product damage.

WARNING

PERSONAL INJURY

DO NOT USE these products as safety or emergency stop devices or in any other application where failure of the product could result in personal injury.

Failure to comply with these instructions could result in death or serious injury.

WARNING

MISUSE OF DOCUMENTATION

- The information presented in this datasheet is for reference only. Do not use this document as a product installation guide.
- Complete installation, operation, and maintenance information is provided in the instructions supplied with each product.

Failure to comply with these instructions could result in death or serious injury.

WARRANTY/REMEDY

Honeywell warrants goods of its manufacture as being free of defective materials and faulty workmanship. Honeywell's standard product warranty applies unless agreed to otherwise by Honeywell in writing; please refer to your order acknowledgement or consult your local sales office for specific warranty details. If warranted goods are returned to Honeywell during the period of coverage, Honeywell will repair or replace, at its option, without charge those items it finds defective. **The foregoing is buyer's sole remedy and is in lieu of all other warranties, expressed or implied, including those of merchantability and fitness for a particular purpose. In no event shall Honeywell be liable for consequential, special, or indirect damages.**

While we provide application assistance personally, through our literature and the Honeywell web site, it is up to the customer to determine the suitability of the product in the application.

Specifications may change without notice. The information we supply is believed to be accurate and reliable as of this printing. However, we assume no responsibility for its use.

Honeywell
Advanced Sensing Technologies

9680 Old Bailes Road
Fort Mill, SC 29707

www.sps.honeywell.com

Rev A

**THE
FUTURE
IS
WHAT
WE
MAKE IT**

Honeywell