

ACM 150 Air Composition Monitor

Honeywell



Guide to Installation, Operation, and Maintenance

Table of Contents

Introduction	4
Contacts	5
Warranty	6
Safety	7
Technical description and theory of operation	17
Air sampling system.....	34
ACM 150 operating principle	40
Installation environment	43
Installation drawings.....	58
Operation.....	61
Setup menus	81
Shutdown procedure	98
Technical specifications.....	100
Maintenance.....	102
Manual tests and evaluations.....	126
Troubleshooting	135
Appendix A - KBr MSDS.....	137
Appendix B - ZnSe MSDS	142
Appendix C - Glossary.....	150

Introduction

Thank you for selecting a Honeywell Analytics product for your monitoring requirement.

Honeywell Analytics is committed to providing quality products and service. The information outlined in this manual is provided to assist our customers in the correct usage of our products. Therefore, it is important that before the installation or operation of this product, you take the time to read and have a full understanding of this manual.

ACM 150 systems provide multi-point monitoring of air for the presence of gases and the vapors of liquid chemicals. As with any processing system, malfunction and failure can occur due to unforeseen or uncontrollable circumstances. Honeywell Analytics, its officers, managers, engineers, and representatives cannot be held responsible for such failure nor for the customer's negligence or misuse of this equipment. At the very least, follow procedures and recommendations outlined in this document for proper system functioning.

The information in Honeywell Analytics' published engineering specifications, manuals, and guides are correct as of publication date. Honeywell Analytics is not responsible for product application, including but not limited to compatibility with other equipment. Honeywell Analytics shall not, under any circumstances, be liable to buyer or any other party for lost profits, diminution of goodwill, or any other special or consequential damages with respect to any claim. In addition, Honeywell Analytics' liability for warranty claims shall not, in any event, exceed the invoice price of the product claimed defective, nor shall Honeywell Analytics be liable for delays in replacement or repair of product.

Honeywell Analytics makes no warranties or representation with regard to the information outlined in this manual and reserves the right to make changes in the specification(s) of the product described within at any time without notice and without obligation to notify any person(s) of such modifications or revisions.

Gas detection equipment must be installed in the correct locations. Failure to do so will render the equipment ineffective. Please refer to local codes of practice or national standards for advice.

Installation in hazardous areas must comply with your local codes of practice or national standards. Equipment installed in hazardous areas must not be serviced in the area unless it is classified "non-hazardous".

Only authentic Honeywell Analytics spare parts may be used for repair and maintenance. Modifications of components are not authorised. Usage of any parts other than Honeywell Analytics render the warranty null and void.

No unauthorised distribution and/or reproduction in any form electronic, verbal, store in a retrieval system, computer language of any kind, mechanical, manual or otherwise, of this information in any form is not permitted without the express written authorisation of Honeywell Analytics.

Notes:

1. "Honeywell Analytics" is abbreviated "HA" throughout this document.
2. The ACM 150 monitor gas list is updated frequently. Please contact us for the latest version.
3. The ACM 150 Air Composition Monitor is manufactured by: Life Safety Germany GmbH, Elsenheimerstr. 43, 80687 München, Germany

Contacts

www.honeywellanalytics.com

Europe, Middle East, and Africa

Life Safety Distribution AG

Javastrasse 2

8604 Hegnau

Switzerland

Tel: +41 (0)44 943 4300

Fax: +41 (0)44 943 4398

gasdetection@honeywell.com

Americas

Honeywell Analytics Inc.

405 Barclay Blvd.

Lincolnshire, IL 60069

USA

Tel: +1 847 955 8200

Toll free: +1 800 538 0363

Fax: +1 847 955 8208

detectgas@honeywell.com

Asia Pacific

Honeywell Analytics Asia Pacific

#701, Kolon Science Valley (I)

43 Digital-Ro 34-Gil, Guro-Gu

Seoul, 152-729

Korea

Tel: +82 (0)2 6909 0321

Fax: +82 (0)2 2025 0388

analytics.ap@honeywell.com

Technical Services

EMEA: haexpert@honeywell.com

US: ha.us.service@honeywell.com

AP: ha.ap.service@honeywell.com

ACM 150 standard warranty

The following warranty is between the Purchaser and Honeywell Analytics known hereafter as Seller.

- Seller warrants that for a period of one year after on-site start-up, its products shall be free from defects in material and workmanship provided that inspection by seller indicates such defects developed under normal and proper use.
- Any product found to be defective shall be repaired or replaced at Seller's option. Goods that have been repaired or replaced during the warranty period are under warranty for the remainder of the unexpired portion of the original warranty period.
- Seller will replace or repair defective products when delivered F.O.B. Seller's plant freight prepaid or at another location designated by Seller. If upon Seller's examination it is determined that the equipment is defective and failed under normal use and service, Seller shall correct such defects at its expense including return freight charges.
- Seller's warranty does not apply to damage resulting from improper installation, misuse, abuse, neglect or accident. Components that are expendable in normal use are not covered by this warranty.
- If the Seller determines that failure of its products is not due to defective materials or workmanship or in the event that the failure occurs after expiration of the warranty period, Seller's standard charges for labor, materials, expenses and transportation shall be paid by Purchaser.
- End products supplied by Seller which are manufactured by others are covered by the manufacturer's standard warranty. Seller shall transfer its warranty for such items to Purchaser and shall assist Purchaser with his warranty claims on these products. Such products which might be included in Purchaser's order but which are specifically excluded from Seller's warranty, are identified below:
 - Personal computers and peripherals
 - Printers
 - External monitors
 - Network hubs

The foregoing is in lieu of all warranties, expressed or implied, including the warranties of merchantability and fitness for a particular purpose; nor shall Seller be liable on the basis of a claim for negligent equipment design or manufacture; nor shall seller be liable for any consequential or incidental damages for any reason whatsoever.

Safety

This section highlights key safety and ergonomics issues related to using the ACM 150 monitor. Matters addressed include risk analysis, chemical safety, electrical safety, flammability, and ergonomics.

Safe and proper operation of the ACM 150 monitor

The ACM 150 monitor design assures that an operator using local keypad and display is protected from injury. Likewise, there is no danger to the operator from opening the inner door or removing the pump cover on the ACM 150 monitor for inspection purposes. No internal plates, shields or components should be touched, tested, removed or serviced except by a trained technician. The user must read and follow all warning labels on the monitor and the highlighted CAUTION, WARNING and DANGER notes contained in this manual.

If the ACM 150 monitor is used in a manner not specified in this manual, the protection provided by the equipment may be impaired.

End user responsibilities

Use only the most current revision of this manual. The information in Honeywell Analytics' published engineering specifications, manuals and guides are correct as of publication date. Honeywell Analytics is not responsible for product application, including but not limited to compatibility with other equipment.

The end user and their subcontractors must be responsible to assure that their respective employees receive hazardous communication training which meet or exceed OSHA 29CFR 1910.120 (hazardous waste operations and emergency response). End users and their subcontractors who work on the ACM 150 monitor are required to assure that their respective employees are provided with material safety data sheets from their Environmental Health and Safety (EHS) department for all gases and/or chemicals which are monitored by the ACM 150 monitor.

Proper functioning of the ACM air composition monitor must be verified after all repairs. The performance of the ACM air composition monitor may be impaired if it is not used as specified in this manual.

Safety notices and terms

Review this manual carefully. Always follow approved safety procedures, including the use of lockout/tagout devices, proper clothing, and eye and face protection. Pay particular attention to warnings and precautions in this manual.

The following is an example of warnings used in this manual

(Please read carefully instructions anywhere a Warning or Danger is used in the manual):

Danger/Warning/Caution/Notes

DANGER

Warns about hazards that will cause serious personnel injury, death or major property damage if ignored.

WARNING

The warning notice identifies potentially dangerous situations, where improper actions could cause death or serious injury

CAUTION

The Caution notice is a general hazard which identifies situations where improper actions could cause damage to the equipment or product.

NOTE

Indicates special instructions that are important but not related to hazards.

Levels of ACM 150 user

This manual is designed for three levels of users, which are described below. The levels are not intended to restrict sections of the manual to specific users. The purpose of the levels is to limit decisions and tasks to users that have the responsibility, experience and/or training to make the decisions and perform the tasks.

All users

All of customer's employees who have a responsibility to install, operate, program, service or use the ACM 150 are defined as All Users.

Authorized users



This icon identifies Authorized Users. The customer's employees who have EHS, ERM, facility and/or management level responsibility for the ACM 150 monitor are defined as Authorized Users. Such users make decisions about the ACM 150 monitor set-up and use, the location of monitoring points, the use of data produced by the ACM 150 monitor, response to warn and alarm activation levels and incidents and the response procedures.

Trained technician

This icon identifies Trained Technicians. Definition of a Trained Technician:

- A Honeywell Analytics employee who is a service technician, chemist or engineer.
- An employee of the user's company or a third party service company who is a service technician or engineer and who has received training from Honeywell Analytics or its agent on the operation and service of the ACM 150 monitor and who is authorized by his/her company to perform this service.
- A Honeywell Analytics agent who is a service technician or engineer and who has also received training from Honeywell Analytics on the operation and service of the ACM 150 monitor.

Personnel not included in one of these categories are not authorized service technicians. On an emergency basis, an operator who is not trained as an authorized technician may be asked to open the doors of the ACM 150 monitor, observe operations and report to a trained technician at Honeywell Analytics (or its agent company). Corrective actions may be recommended based on those observations.

Danger

Electrocution can occur when dealing with electrical circuits. Under no circumstances shall an untrained person be permitted to access, test, touch or remove any electrical circuits, plates or shields in the ACM 150 monitor. Refer to [Lockout / Tagout Procedure](#) before servicing the ACM 150 monitor.

danger

L'électrocution peut se produire lorsqu'ils traitent avec des circuits électriques. En aucun circonstances sont une personne non formée autorisés d'accès, de test, tactile ou supprimer tous les circuits électriques , plaques ou de boucliers dans le moniteur ACM 150 . Référer à verrouillage / Procédure Tagout avant de réparer le moniteur ACM 150 .

Risk analysis

The use of The ACM 150 Air Composition Monitor entails inherent safety risks. Hazards include fluidics hazards, chemical hazards, physical hazards and electrical hazards. Fluidics hazards come from pressurized sample and air lines. Chemical hazards include the hazards associated with the air sample and the hazards related to the various components within the monitor. Physical hazards involve maintenance or removal of some heavy components inside the monitor. Electrical hazards include the high voltage (110/220 VAC) located within ACM 150 enclosure.

Chemical safety

Located within the sample gas cell are two windows made of a potentially toxic material called ZnSe (zinc Selenide). An MSDS for ZnSe is included in Appendix B. Special attention to the MSDS should be given and appropriate precautions taken by the user when performing maintenance on the gas cell

The majority of the time the ACM 150 monitor is operating, it is sampling ambient air without toxics. In the event of a toxic gas release at one of the sample points for the monitor, small amounts of toxic gas and/or residue may be trapped inside the sample tubing, filters and pumps inside the monitor. During normal operation these trapped gases will be purged through the monitor and pose little risk as they are diluted before being sent out the exhaust.

However, during maintenance procedures that involve disassembly of these components, care is advised to make sure that if the monitor has experienced a toxic gas release, appropriate protective equipment is used to ensure user safety. It is also the responsibility of the user to dispose of all contaminated parts and service items such as filters and wipes per local rules and procedures. Refer to section 9 for further details.

Process compatibility

All components are compatible with the materials in the ACM 150 monitor. All sample-wetted materials are PFA, PTFE, PVC, acrylic, stainless steel, anodized aluminum or glass. The normal operating pressure of the sample-wetted components is a vacuum, however most of these materials are designed to withstand a maximum pressure of 80 psi at room temperature.

Some of the flexible lines contain high pressures. The burst pressure of the internal flexible tubing as originally supplied is dependant on its sizes:

- 1/4" (heavy wall) has a burst pressure of 270 psig at 70°F
- 3/8" (heavy wall) has a burst pressure of 230 psig at 70°F
- 1/2" (heavy wall) has a burst pressure of 155 psig at 70°F

To protect against rupture from an abnormal pressure condition, a pressure relief valve is provided. Do not remove or modify this pressure relief valve.

CAUTION

Failure to operate the ACM 150 monitor within the pressure and temperature limits specified can cause leaks. Only operate the ACM 150 monitor within the pressure and temperature limits specified.

MISE EN GARDE

Défaut d'utiliser le moniteur ACM 150 au sein de la pression et de température limites spécifiées peuvent provoquer des fuites . Seulement utiliser le moniteur ACM 150 au sein de la les limites de pression et de température spécifiées.

Electrical safety

Tools are required to access sections of the ACM 150 monitor with electrical connections. An appropriately sized ball driver or allen wrench is required to access the interior portions of the enclosure. A Phillips screwdriver is required to access the power cords at the AC power distribution unit, located immediately behind the computer door. A Phillips screwdriver is also required to open the main power disconnect switch on the top of the cabinet. There are no hardware electrical interlocks on the ACM 150 monitor.

A “Lockout/Tagout” power isolation box is installed on the top of the monitor’s enclosure. Before any electrical repair work is started, turn the knob to the “0” position to isolate main power to the monitor. To return power to the monitor, turn the knob to the “1” position. If it is necessary to enter any electronic areas, electrical energy may be stored within the system. Allow sufficient time for any power to discharge and use a voltmeter to check before doing any work in the area. Do not perform any internal electrical work on the monitor without using the correct procedures (Lockout/tagout (LOTO) disconnect). Lock out and tag out the main power switch per local safety procedures.

A circuit breaker for the main power supply must be provided by the user per local electrical codes.

Hazardous Energy Isolation

The ACM 150 monitor uses both high pressure CDA (compressed clean dry air up to 100 psig) and low pressure (5 psig) nitrogen. Both of these energies may be stored inside the monitor and must be relieved before performing any maintenance work involving the pneumatics. The CDA is used by the venturi vacuum generators located inside the main enclosure behind the computer door. Nitrogen is used to purge the sample gases between analysis cycles and is plumbed to the solenoid valve assembly located next to the optics bench inside the cabinet.

It is the responsibility of the customer to install external lockable manual isolation valves for both the CDA and the nitrogen supply. The valves should be visible, easily accessible, properly labeled and close to the monitor. It is recommended that a pressure gauge be installed to visually indicate the supply pressure.

Refer to the installation instructions i for additional details and precautions. A class 1 laser is part of the ACM 150 monitor optics bench. During any maintenance procedures that involve servicing the optics bench or its components, electrical power should always be disconnected.

The noise generated during operation of the ACM 150 monitor has been measured to be less than 70 dB.

Compressed Air Isolation

Compressed air can be isolated by ensuring that during installation or setup of the ACM 150 monitor compressed air isolation valves for the supply have been installed. Since each site's requirements vary, it is up to the end-user to provide this isolation. Compressed air stored energy can be removed by first shutting off the air supply and then allowing time for the pressure to bleed down. Under normal automatic operation the pressure should bleed down through the venturis in seconds. Under manual operation, it may be necessary to actuate the venturi supply solenoid valve briefly to bleed off the pressure. Pressure gauges are provided on the venturi manifold assembly to help verify that the pressure has been relieved.

Nitrogen Isolation

Nitrogen under low pressure purges sample gases between cycles. It also provides continuous purging of the optics bench mirrors through a small orifice. Shutting off the nitrogen supply should relieve any stored pressure through the optics bench purge without any further actions.

Emissions

The ACM 150 monitor does not emit or generate hazardous levels of ionizing/non-ionizing radiation or audio noise.

Ergonomics

Ergonomic factors such as the height and weight of the monitor do not pose a significant hazard. The height of the monitor should be at a comfortable level, with the computer approximately 4 feet above the ground. It is recommended that a work stool be used while working for long periods.

There are two heavy components that may need infrequent servicing or replacement every few years.

The optics bench contains components that can be replaced by Honeywell Analytics. Care should be exercised when lifting and removing the optics bench. When removing the optics bench for off-site service, Honeywell Analytics suggests an adjustable height wheeled platform or dolly be positioned level with the optics drawer. With the drawer open, the bench can then be slid onto the platform and transported as needed safely.

The backup exhaust pump is also heavy. Should the pump need replacing, care should also be exercised.

Flammability

The construction of the ACM 150 monitor enclosure consists of nonflammable materials. All high voltage (110/220VAC) is contained within nonflammable enclosures.

Potential key failure points and trouble spots

Potential key failure points and trouble spots can include, but are not limited to:

- Chemical exposure due to leaking fittings
- Chemical exposures due to maintenance activities
- Potential electric shock from servicing electrical components

Methods to avoid potential hazards include the use of personal protective equipment, various system level safety interlocks and administrative controls.

Potentially hazardous maintenance activities

When performing maintenance on the ACM 150 monitor, especially for those installations that have had hazardous gas alarm incidents, purge all sample lines with air or nitrogen to prevent exposure to hazardous chemicals. Also, when performing maintenance on the sample cell or any components that may trap or collect hazardous gas, use appropriate protective equipment to limit exposure to any possible gas sample residue.

Environmental issues

Environmental issues involve the proper disposal of potential hazardous wastes generated during maintenance procedures. The following ACM 150 monitor components are potential hazardous materials and may need infrequent replacement:

- Lithium battery inside computer
- Gas sample filter inside pump cabinet
- End-of-line filters and check valves if installed
- Cleaning wipes and materials such as gloves
- Sample tubing and solenoid valves

Other materials in the sample stream that may have come in contact with hazardous gases should also be considered potentially hazardous. Contact your local environmental management agency or a hazardous waste management company for proper recycling and/or disposal sites and procedures for these components.

Exhaust treatment

The ACM 150 monitor exhaust must be connected to the customer's exhaust system within their facility. In the event of a hazardous gas release and subsequent gas alarm, the sample gas is expelled out the exhaust connection. It is substantially diluted under normal conditions as it exits the monitor and poses little danger, however proper treatment is advised. Only the end-user can decide if those emissions should pass through an acid scrubber or alternatively, untreated through a general exhaust system. It is up to the end-user to abide by all local safety procedures.

ACM 150 labels

The exterior and interior labels for the ACM 150 monitor are shown on the following pages. These labels are applied by the factory prior to shipment.

NOTE

If any label is absent or loose, please notify Honeywell Analytics. A new adhesive label will be sent. It may be applied to the ACM 150 monitor, as shown in the drawings, by the user or by one of our service engineers.

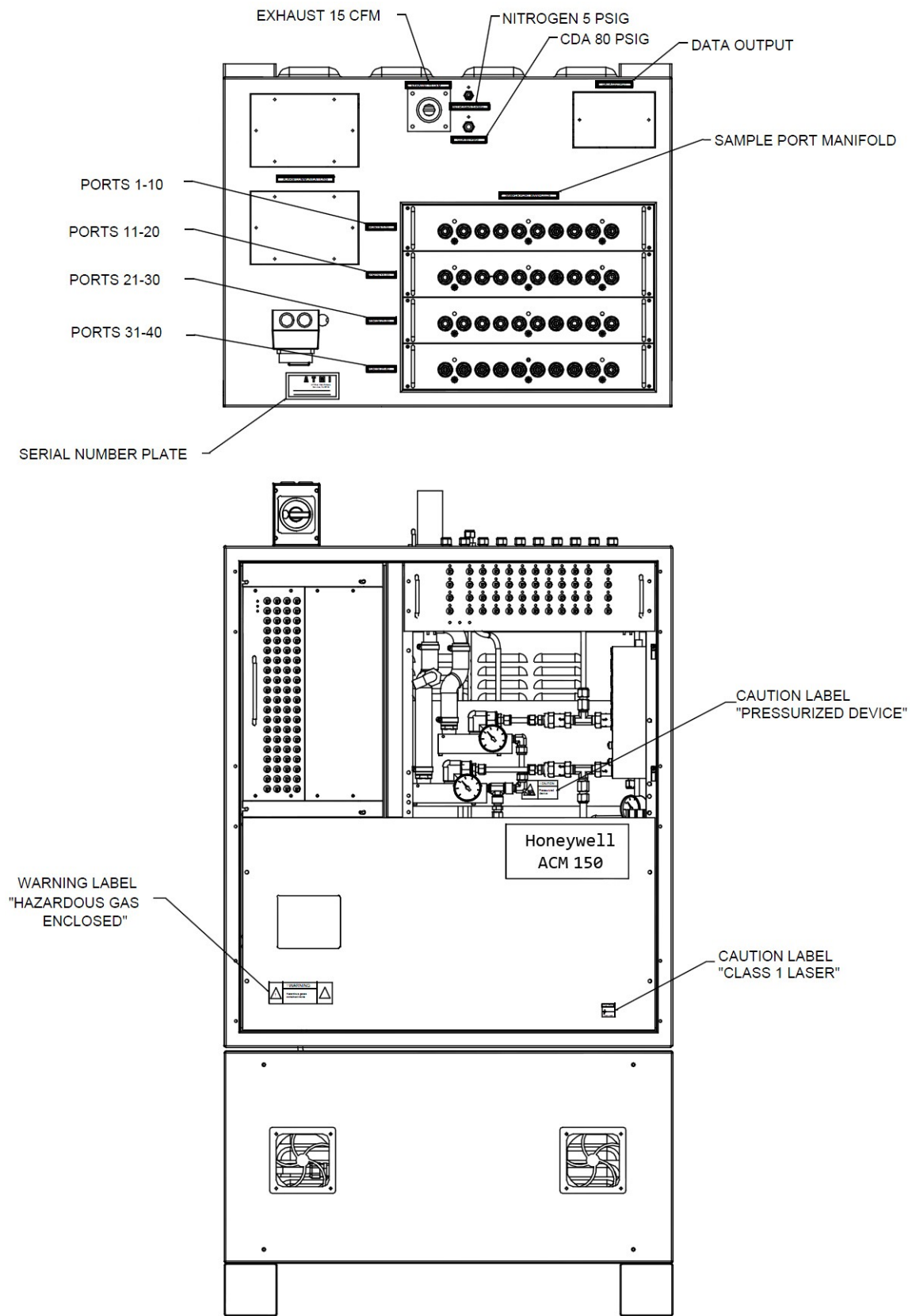

Figure 1. ACM 150 outside labels

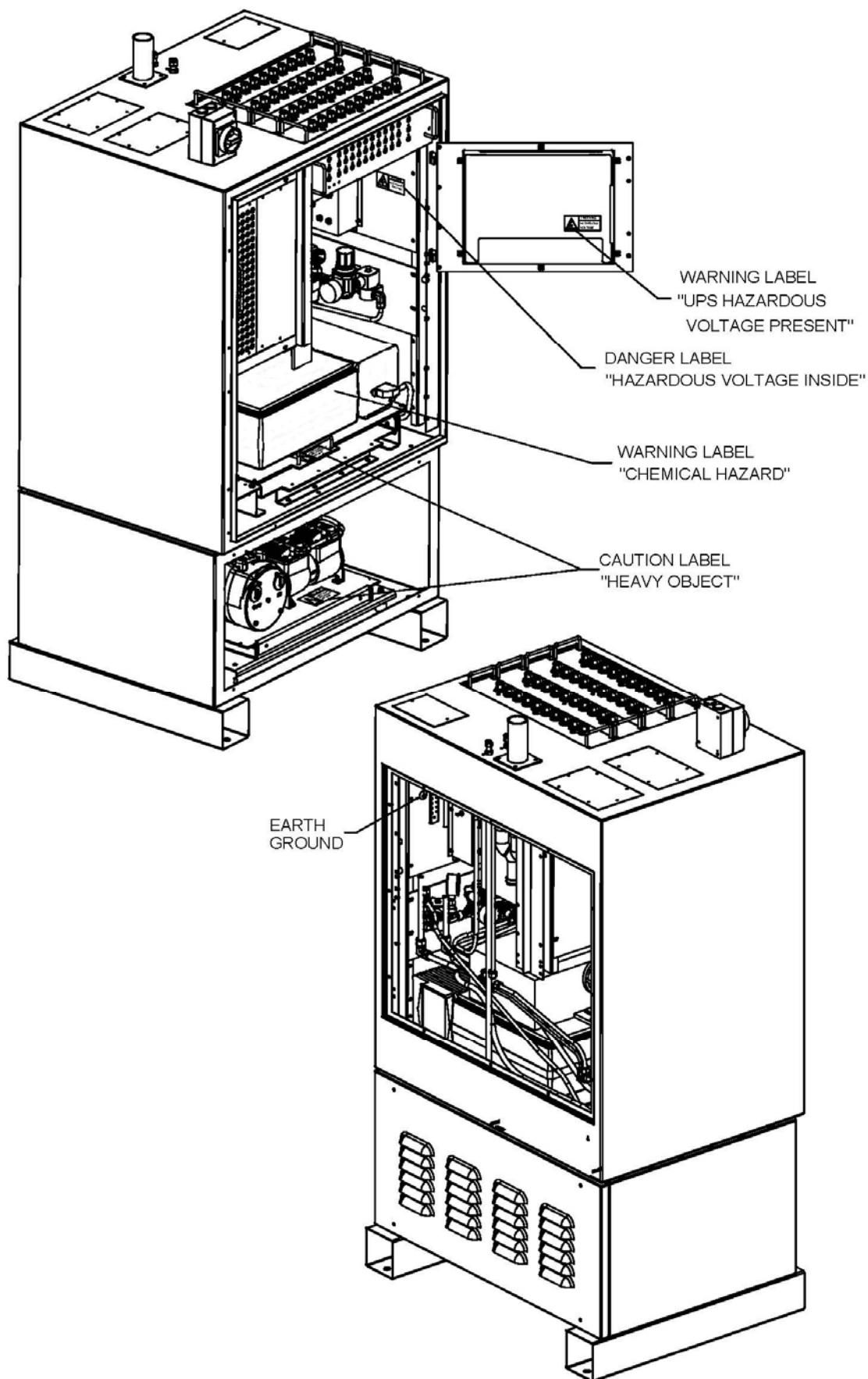



Figure 2. ACM 150 inside labels

ICON KEY	
	Authorized Users
	Trained Technician

Technical Description and Theory of Operation

Overview of the ACM 150 monitor

The ACM 150 monitor can monitor any or all of the following locations:

- Sources of a potential chemical leak, such as gas cabinets, valve boxes, pipes, process equipment, semiconductor tools and storage areas to alert emergency response teams of a pending problem and/or to shut off the flow of gases automatically.
- Plant emission ducts and stacks to determine the concentrations of various chemicals being released from the facility.
- Workplace areas to confirm that employees are not being exposed to chemicals and to alert workers should a leak spread into their breathing zone.

The ACM 150 samples the air in these locations and analyzes it for a large number of gaseous chemicals. The samples are transferred to the ACM 150 monitor by 3/8 inch Teflon tubing or polypropylene. At or near the sample pick-up locations (tube inlets), an air filter is installed to keep the sample lines free of particles. As an option, a check valve can be added after the filter to allow the line to be pressurized with air from the ACM 150. This enables an automatic leak check of every sample tube once per day.

The ACM 150 monitor does not monitor all locations at once. It scans one area at a time, in sequence until all active areas have been monitored. It has the capacity to scan as many as 40 sample areas.

ACM 150 arrangement and assemblies

General arrangement

The ACM 150 monitor cabinet consists of these assemblies:

1. Main Power Switch
2. Sample Valve Manifolds
3. Sample Valve Control Panel
4. Touchscreen Computer Assembly
5. FTIR-Bench and Gas Cell Assembly
6. Pumps and Pump Cabinet
7. Cycle Valves and Cycle Valve Control Panel
8. Router
9. Relay Output Control Panel
10. Relay Outputs



Figure 3. General arrangement

Main power switch

This switch controls the line power. The ACM 150 monitor can not operate unless it is switched ON. Switching it OFF disconnects line power to all ACM 150 assemblies. This is also a Lockout/Tagout (LOTO) switch. It accepts an external padlock in the OFF position.



Figure 4. Main power switch

Sample valve manifolds

Located at the top of the cabinet, these manifolds are aluminum and then Teflon impregnated and hard-anodized to provide an inert surface.

Each manifold holds 10 valves. These are 3-way solenoid valves operated by 24 VDC. One way flows to a bypass header and the other to a sampling header that connects to the cycle valves and the FTIR gas cell. The valves mount upside down. They are secured by screws and o-rings seal them to to the manifold.



Figure 5. 10 Sample valve manifold

One to four manifolds are installed, providing 10, 20, 30 or 40 sample point inlet fittings. Blank plates seal off unused manifolds. Handles are provided for installation and removal of the manifold assemblies. Shown below are the sample tube fittings on the manifolds.

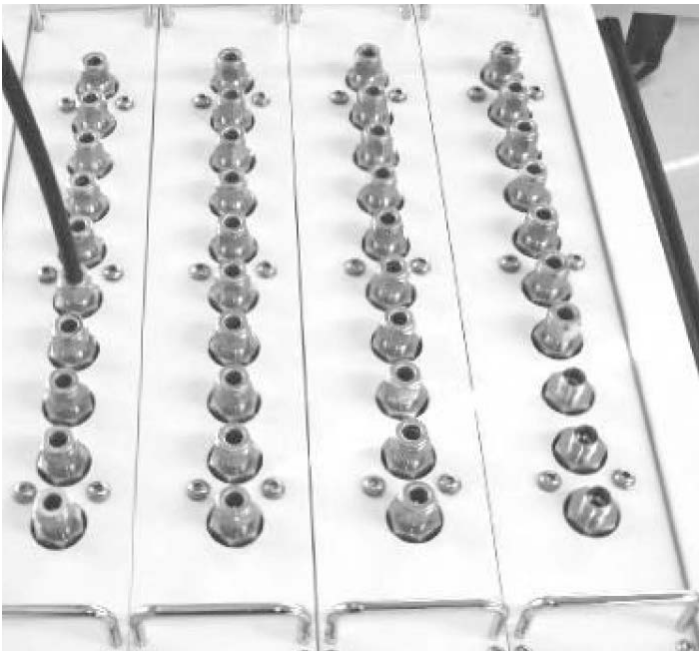

Figure 6. Sample Inlets 40-Point

Sample valve control panel

The Sample valve control panel provides both status and control. As the ACM 150 monitor switches the sample valves from one area to the next, the corresponding LEDs light indicate the current valves being sampled and analyzed. Each area number is also a momentary test switch, which may be pressed and used for test purposes when the ACM 150 monitor is in the Front Panel Mode. In other modes the switches are inactive.

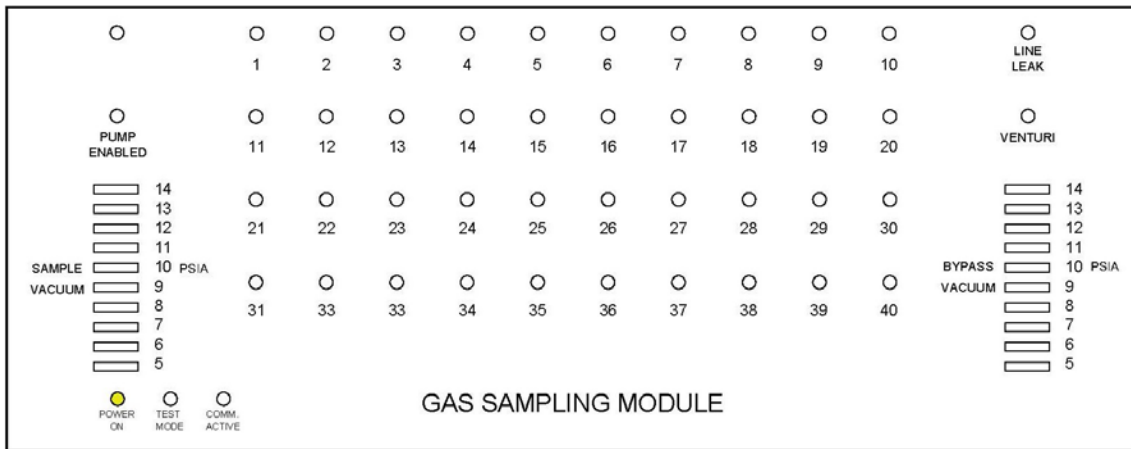

Figure 7. Sample valve control panel

A column of LEDs on the left and right sides indicate the vacuum, measured in psia, in the bypass flow (Bypass Vacuum) and in the sample flow (Sample Vacuum). They are a troubleshooting aid should the vacuum fall below acceptable levels. Status LEDs are provided for the following:

- Pump Enabled: The LEDs indicate adequate sample pump vacuum
- Venturi: The LEDs indicate adequate venturi pump vacuum
- Line Leak: Lights when the ACM 150 monitor is performing a Line Leak Test, which may be initiated manually or automatically. In order for the Line Leak Test to perform properly, check valves must be installed in the sample lines connected to the ACM 150 monitor. This feature may be disabled via the configuration software.

Control panel status

The three control panels on the ACM 150 monitor have the same Status LEDs. These LEDs provide status on the following:

- Power On: Lights to confirm that power is supplied to the valves or relays associated with the Control Panel. This LED should be lit whenever the ACM 150 monitor is powered. Loss of power requires service attention.
- Test Mode: Lights when selecting the Manual Mode or Frontpanel Mode on the touchscreen.
- Comm. Active: Flashes when the computer and the control panel are communicating. Frequent communication is normal.

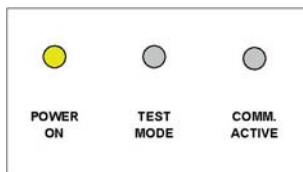

Figure 8. Control panel status LEDs

Cycle valves

When a sample area is selected by the computer, the corresponding sample valve diverts the flow path from bypass to sample. The boost pump draws the air sample in and pumps it to the gas cell. The boost pump connects to the gas cell through the cycle valve assembly.

Solenoid valves S1, S2, S5, and S6 are the cycle valves. They control the flow path of the air samples, ensuring the spent sample is evacuated from the gas cell and filled with fresh sample before each analysis. They also switch to nitrogen during the background cycle. The timing and switching is controlled by the computer using a program that is configurable.

All valves are 24 VDC, 2-way, and normally closed (energized to open). These valves are mounted on a removable plate.

Valves S1 and S2 contacting the air sample before it passes to the gas cell have Teflon bodies, S5 and S6 are made of stainless steel.

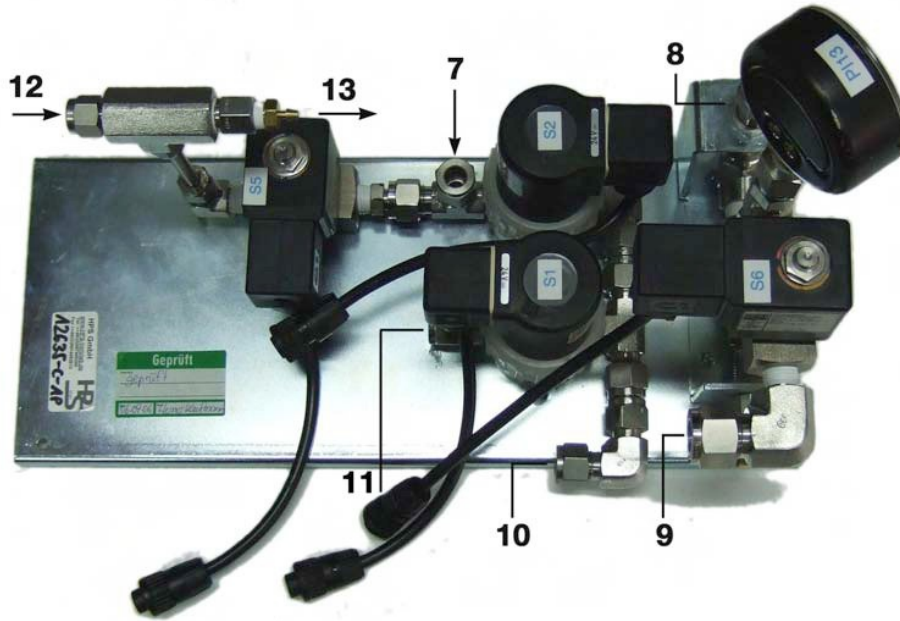

Figure 9. Cycle valve assembly

S1, S2, S5, S6: Solenoid Cycle Valves

PI13 Pressure Indication

7. Gas Cell In

8. Gas Cell Out

9. Depending on option, either / or:

To Venturi Manifold

Exhaust Pump In

10. From Boost Pump

11. To Exhaust

12. Nitrogen In

13. To Dust Cover Purge

Cycle valve control panel

The Cycle Valve Control Panel provides both status and control, much like the Sample Valve Control Panel. Status indicators include:

- **Sample Pressure:** This scale is psia or absolute pressure, as measured at the gas cell.

The pressure is lowest during the Evacuation cycle. It peaks during the Analyze and Background cycles (~ atmospheric or 14.7 psia). The scale is used to confirm proper operation of the pumps and cycle valves.

- **Cycle Status:** LEDs light to show the stages of the scan cycle from Evacuation to Analyze. The scan cycle is explained in “Air sampling system” on . Green LED indicates the status is OK. Amber LED indicates a possible problem, i.e.

inadequate pressure during the cycle.

- ZPD: The Zero Path Difference indicates the intensity of the infrared signal measured by the detector.
- If the values are no longer in the green range, there may be a problem requiring service attention.
- Control Panel Status: Refer to [Control panel status](#). The Power On, Manual Mode and Comm. Active LEDs have the same functions on all three control panels.

The LEDs 1 to 8 light to indicate which valves are active during each sampling cycle. LEDs 1 to 6 correspond to valves S1-S6 with S7 and S8 provided for future use. When the ACM 150 monitor is in the Frontpanel Mode, press the buttons to activate the momentary test switches for test purposes. In other modes the switches are inactive.

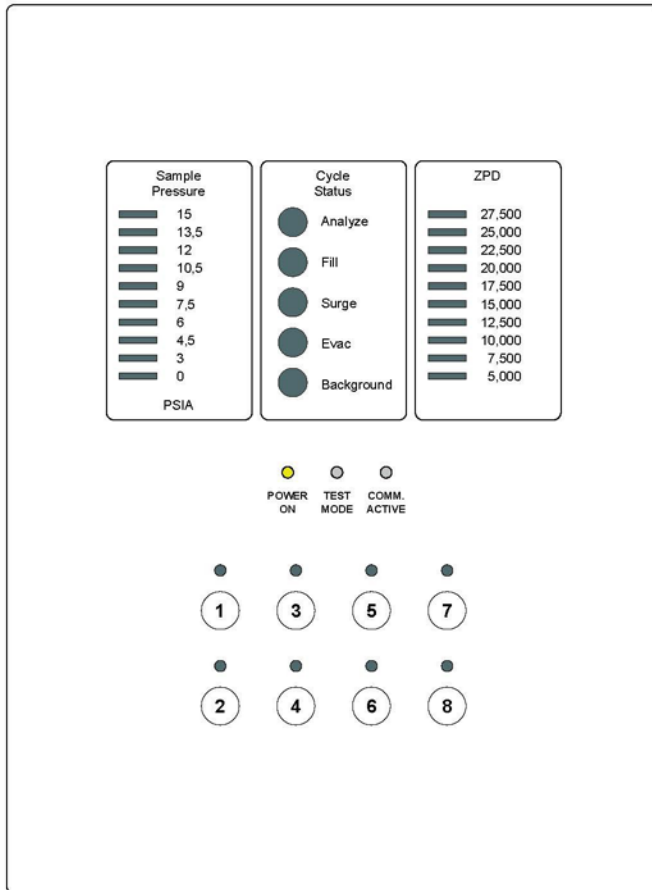

Figure 10. Cycle valve control panel

Pump assemblies

Venturi Pumps

The ACM 150 monitor has two air-driven eductors (venturi pumps). One is the Bypass Venturi Pump. It draws a constant flow of air through the tubes and the sample valves. This flow is only interrupted when the sample valve is energized, i.e. when that area is being sampled by the ACM. When areas are not sampled, they flow to bypass. This assures that the samples lines are continuously flowing and refreshed.

The second pump is the Gas Cell Venturi Pump. It draws spent sample out of the gas cell during the Evacuation mode.

The advantages of the air-driven venturi pump are:

- no scheduled PM service because parts do not wear out
- generates virtually no noise or heat

Should the supply of air be interrupted, a mechanical pump turns on and takes over automatically.

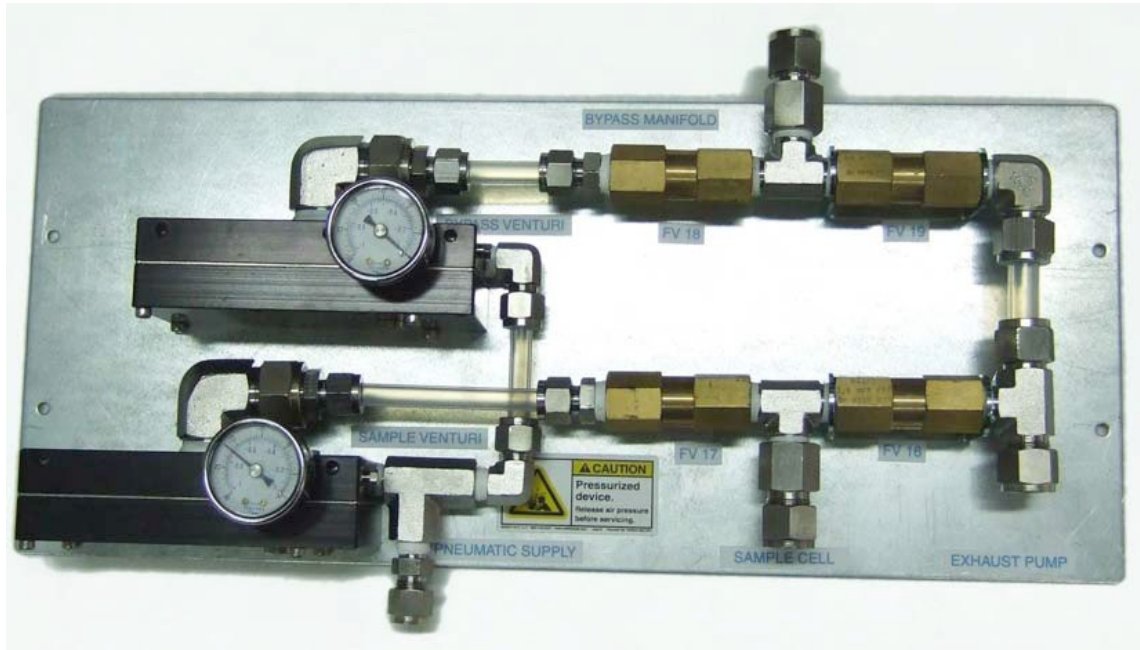

Figure 11. Venturi pump assembly

The venturi pumps are installed on a mounting plate. The check valves allow the venturi pumps and the mechanical Backup Exhaust Pump to be pneumatically coupled to common bypass and gas cell vacuum lines. This allows either one to provide the suction to draw the flow. The mechanical pump switches on automatically when the venturi pumps fail to provide adequate vacuum. The check valves permit flow in one direction only. This prevents the pump in use from drawing on the idle pump.

Mechanical pumps

The pumps are isolated in the bottom section of the ACM 150 monitor to muffle the noise and to isolate vibration and heat. Cooling fans in the bottom section of the cabinet direct air flow across the pumps and their motors. The pumps are accessed by removing the front panel. They are mounted with vibration eliminators on a common plate that slides out for service.

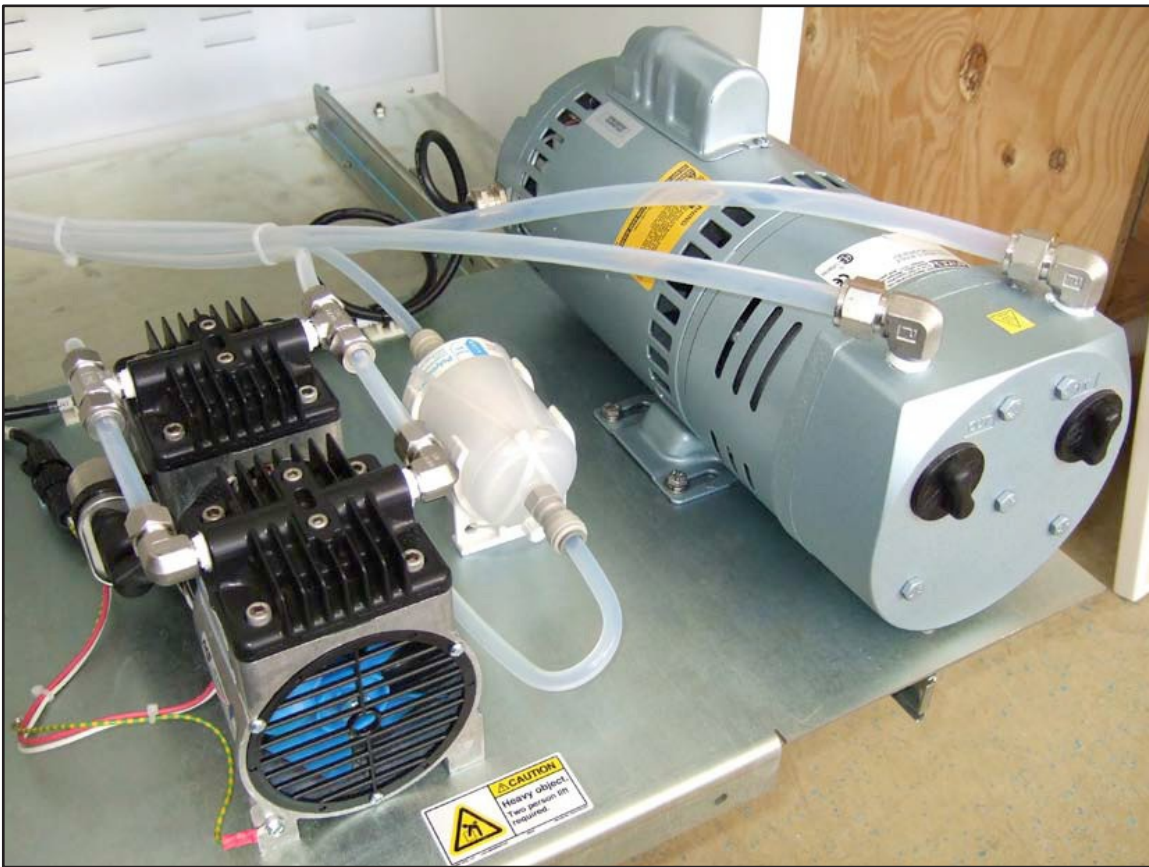

Figure 12. Mechanical pump assembly

The Backup Exhaust Pump is an oil-less carbon vane vacuum pump with a high flow capacity. If air is supplied to the venturi pumps and they are operating properly, this pump is inactive. Insufficient vacuum, when detected by an absolute pressure transducer, automatically applies power to the pump. The backup pump turns on for both venturi pumps under these conditions. When the air supply is restored or the problems are corrected, the user manually switches the ACM 150 monitor from the automatic mode into the manual mode and back to automatic mode, using the Diagnostic menu to use the venturi pumps again.

The Boost Pump speeds up the sampling cycle. It is a dual head diaphragm pump with Teflon coated internal parts. It is always on. In the surge and fill cycles, the boost pump provides a high rate of sample flow into the gas cell. In the evacuation and analyze cycles, it keeps the sampled air flowing to bypass.

FTIR bench & gas cells



Figure 13. FTIR bench assembly

FTIR optics bench assembly

The Optics Bench is a Perkin Elmer Model Spectrum Two FTIR (Fourier Transform InfraRed) analyzer. It is the heart of the ACM 150 monitor, providing the analytical power to identify and quantify a vast array of gases. For more information, refer to [ACM 150 operating principle](#).

The optics bench always includes a gas cell.

Gas Cells

Sampled air never flows through the FTIR Optics Bench. Instead, the samples flow through a gas cell. The infrared beam from the FTIR Optics Bench passes through a window on top of the bench where it is reflected by mirrors and directed into the gas cell. The infrared beam passes through windows in the gas cell, where the gas molecules in the sampled air absorb infrared radiation at wavelengths specific to each gas type. The beam exiting the gas cell is focused by mirrors on the Optics Bench to a detector, where the signal is collected for analysis.

Most ACM 150 applications are for TLV-TWA level monitoring, which require higher sensitivity. The level of detection is at the low ppm and, sometimes, sub-ppm levels.

As the pathlength increases, more gas molecules come in contact with the infrared beam. For this reason, the pathlength of the gas cell is directly proportional to the detection sensitivity. The standard gas cell used in the ACM 150 monitor has a pathlength of 5 meters. The infrared beam is focused and directed into the cell and out to the detector by transfer optics, adjustable mirrors below the cell.

The beam enters and exits the gas cell through windows at the bottom. It is reflected back and forth by the internal mirrors at the top and bottom, making multiple passes through the gas cell. The mirrors have a highly reflective gold coating.

The gas cells mount to a plate that bolts to the FTIR Optics Bench.

Touchscreen computer assembly

Computer assembly

The computer is a single assembly that is panel mounted on a door that swings out for access. The below rear view of the computer assembly shows the power cable and interconnecting cables. The computer connects to the FTIR optics bench via the SBC computer, receiving its data constantly. Cables connect it to all of the valve and relay circuit boards. The computer directly controls all I/O functions. A connector is provided for interface via TCP/IP to internal networks or external computers via the internet.

Touchscreen

The computer has an integral touchscreen on the front. This serves as the user interface at the ACM 150 monitor. A typical display is shown below. Remote users have the same display on their computers and use the mouse instead of touch.

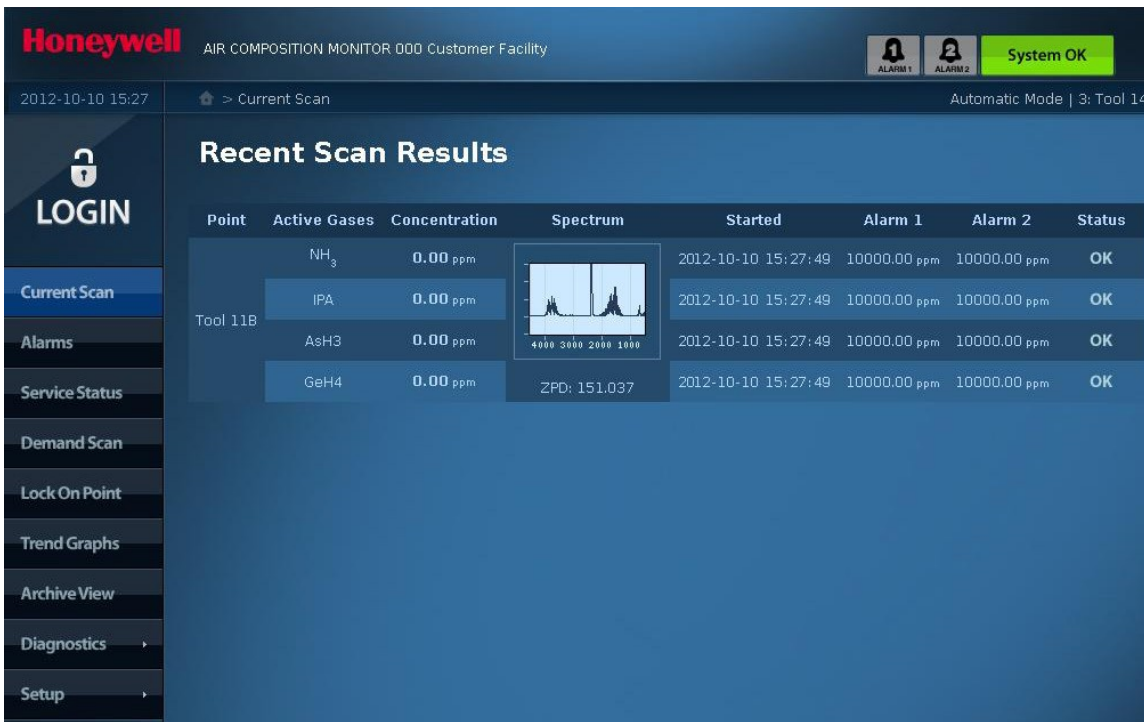

Figure 14. Touchscreen

Keyboard

For the entry of alphanumeric characters the ACM 150 monitor has a keyboard mounted on a slideout drawer below the computer assembly. Pull out the keyboard only when needed. Push the slideout drawer back in to eliminate the risk of injury caused by the protruding drawer.

Relay outputs

The ACM 150 monitor Relay Output Board is shown below. It has 86 relays. Relays #1 to #80 are arranged in 4 rows of 20 relays. These are the programmable relays. By default, they are preset to activate as follows:

Relay #1 to #40: Assigned in sequence to Areas #1 to #40. They are activated whenever any gas monitored at the specific Area (sample point) exceeds the Alarm 1 level set point.

Relay #41 to #80: Assigned in sequence to Areas #1 to #40. They are activated whenever any gas monitored at the specific Area exceeds the Alarm 2 set point.

The user has the option of reprogramming the function of each relay, changing the activation level, assigning specific gases and sample areas or groups of gases, and sample areas.

Relays #81 to #86 indicate the following:

- 81 Power fail
- 82 Watchdog timer
- 83 Manual mode
- 84 General malfunction
- 85 General alarm 1
- 86 General alarm 2

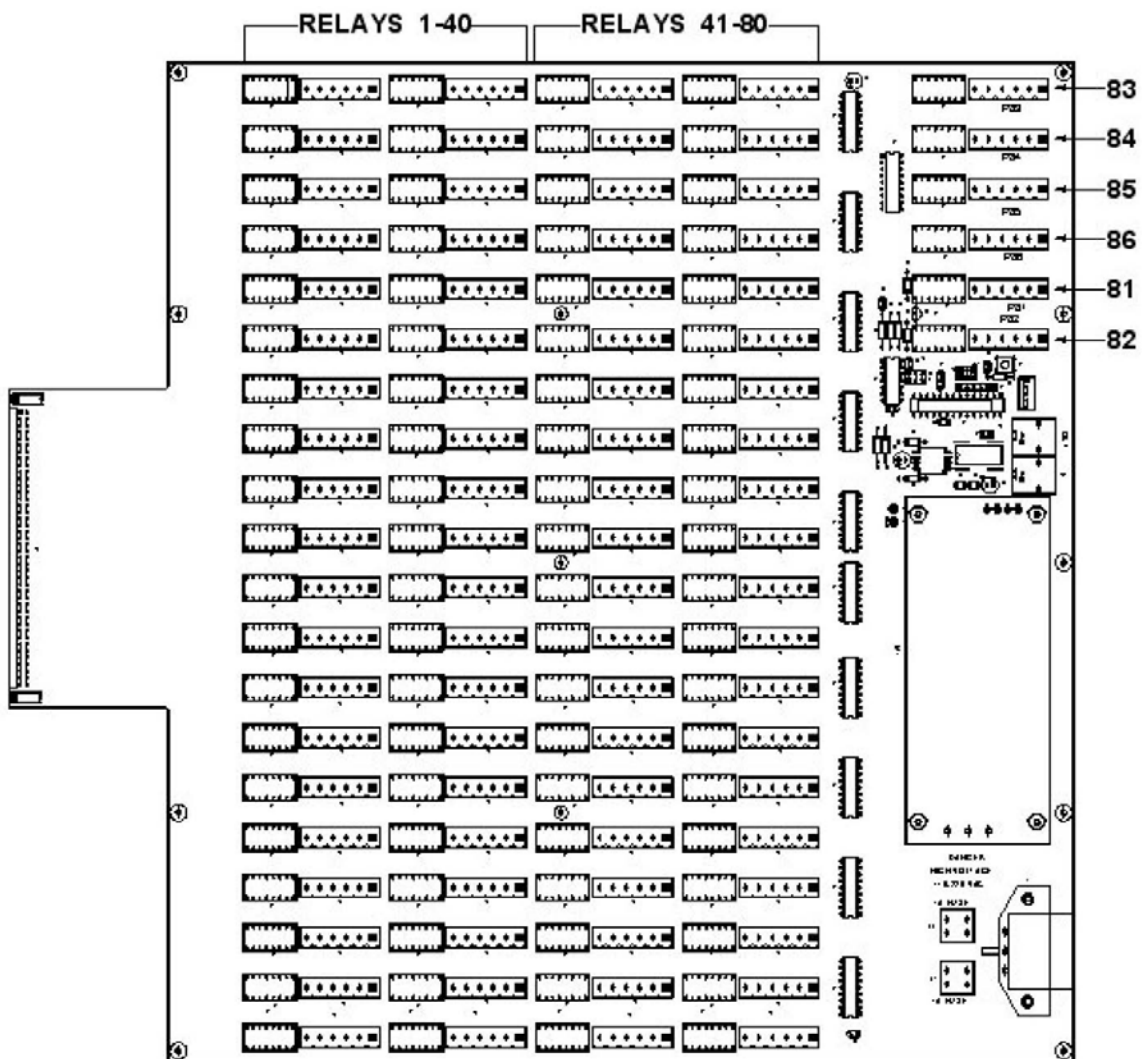

Figure 15. Relay output board

The output relays are provided for interface to PLCs, for direct activation or alarm devices and/or for direct initiation of automatic gas shutdown. They may also be wired to status panels. All relays are double-pole double-throw (DPDT) with dry contacts rated for maximum 30 VDC, 2 A.

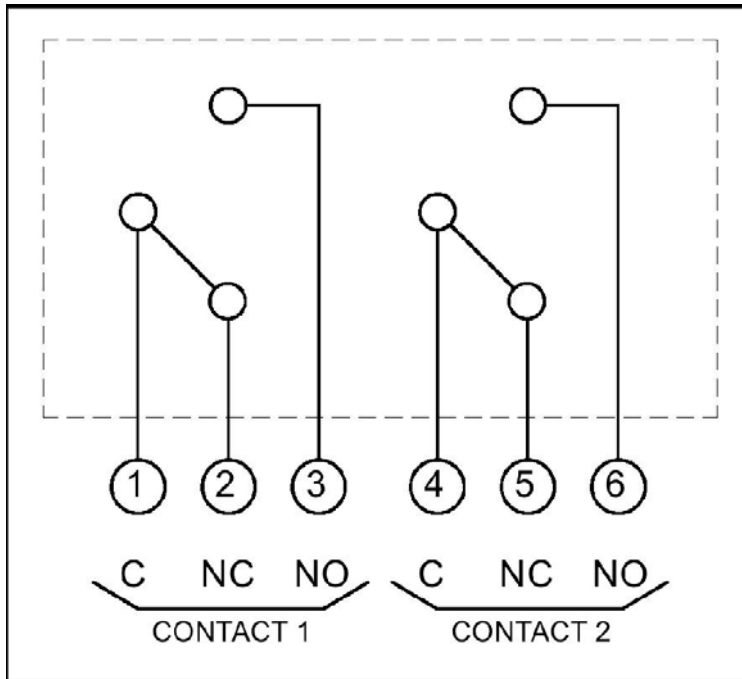

Figure 16. Relay schematic

- Relay shown in normal position - (Deenergized with no alarm present).
- This diagram is typical of all 86 relays.
- Relay number 81 (Power Fail) and relay number 82 (Watchdog) are inverted - power is always on and drops upon a trouble condition.
- Relays number 1 to 80 are programmed by software, relays number 81 through 86 are fixed in function.
- See [Programmable relays](#) for additional information on programming.

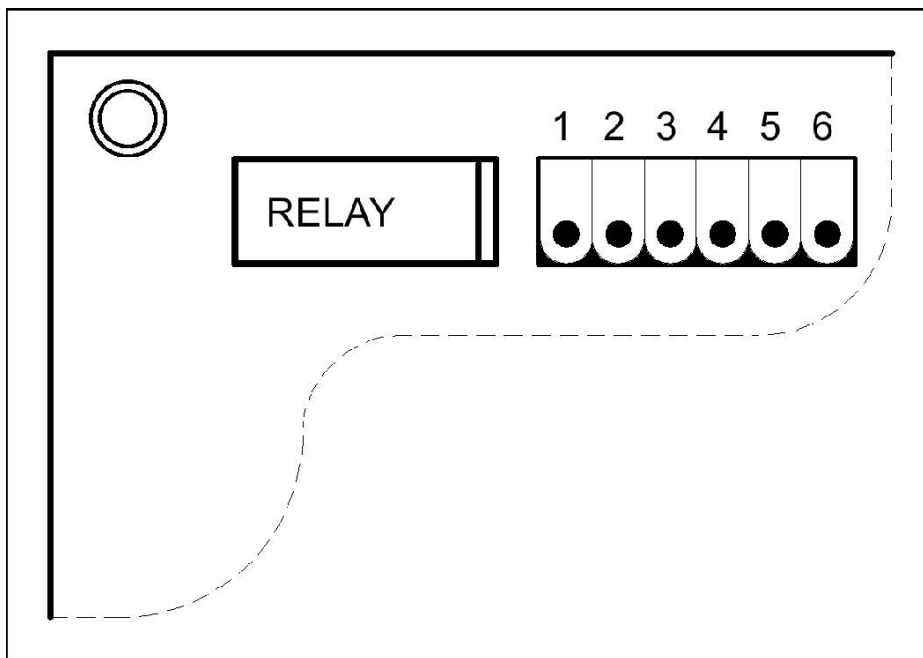

Figure 17. Typical relay layout

- Relay number 1 is shown.
- Typical of all 86 relays.
- See [Figure 15](#) for layout and relay locations.

Relay output control panel

The Relay control panel provides both status and control. When the ACM 150 monitor activates a relay, the corresponding LED lights and remains lit until the condition clears or the relay is reset. The 80 alarm relays have a momentary test switch, which is active in the Front Panel Mode. Relays 82–86 can only be tested from the computer, in the Manual Mode. In other modes the switches are inactive.

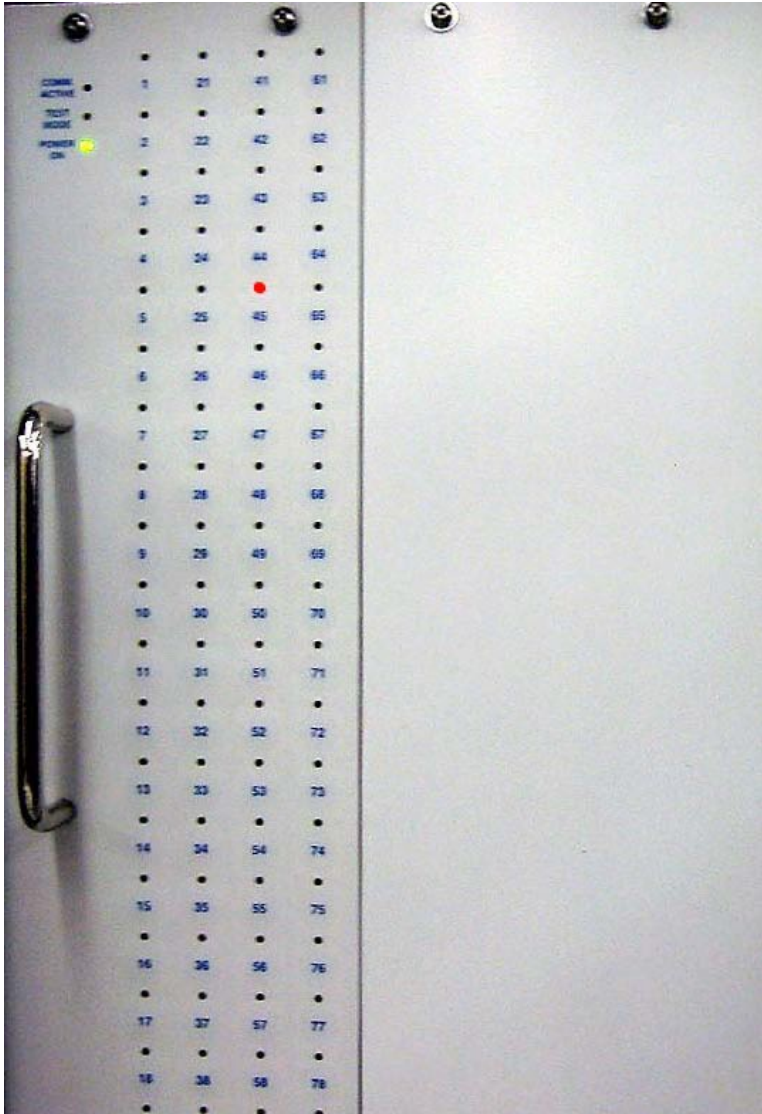

Figure 18. Relay control panel

The Control Panel Status LEDs for Power On, Manual Mode and Comm. Active have the same functions as the other control panels. Refer to [Control panel status](#).

Electrical Layout

Power DISTRIBUTION PANEL

The AC line power from the main power switch wires into the power distribution panel, which is shown below. This panel provides grounded receptacles for power cords wired to the various subassemblies and mechanical pumps in the ACM 150 monitor. Each subassembly has its own DC power supply, if DC power is required. Power to any subassembly can be disconnected by unplugging it from the power distribution panel. The power distribution panel is divided into two fused circuits.

- One 120/230 VAC switched receptacle J20 for the Primary Pump. The power is normally on and is switched off when the vacuum falls below preset levels.
- One 120/230 VAC switched receptacle J21 for the Secondary Pump. The power is normally switched off and is switched on when the Primary Pump fails. A fault message is activated “ACTIVATING SECONDARY PUMP”.
- Twelve unswitched 120/230 VAC receptacles for all of the powered subassemblies.

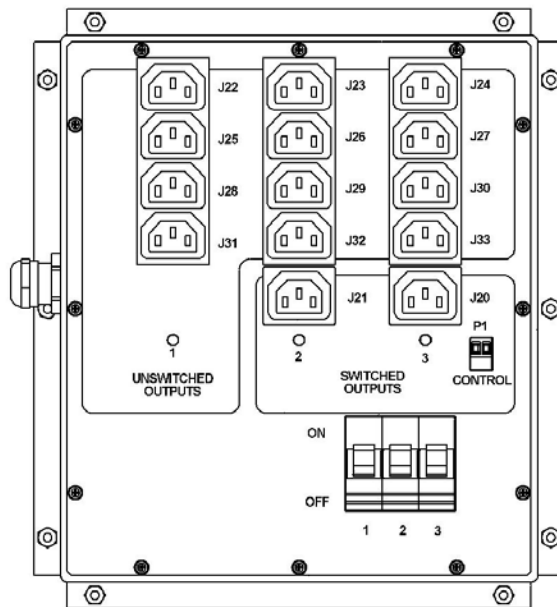

Figure 19. Power distribution panel

Interconnecting cables

On request, Honeywell Analytic can provide a wiring diagram showing all of the power cords and other interconnecting cables in the ACM 150 monitor and the connection points for each cable. Refer to this diagram to determine which cord to unplug when removing power from a specific pump or subassembly. Also, insert plugs into their receptacles as shown on the wiring diagram when power is restored to a pump or subassembly.

NOTE

A 24 vdc signal from the Sample Valve Control Panel goes to the Power Distribution Panel at P1. This controls the Secondary Pump, turning on the power when inadequate vacuum is sensed. To change back to the Primary Pump, switch the ACM 150 monitor from the automatic mode to the manual mode and back to automatic mode, using the Diagnostic menu.

Air sampling system

ACM 150 flow cycles

The ACM 150 monitor is designed to move air samples from one area to the next as quickly and efficiently as possible, while assuring that each sample is fresh and representative of the air at the sampled area when it is analyzed. The Cycle Valves are shown in [Figure 9](#).

The ACM 150 monitor does this by sampling each area in four steps or flow cycles with the following valves opened:

- Evacuate: S1 and S6
- Surge: S2 and S6
- Fill: S2
- Analyze: S1

[Table 1](#) shows the timing range for each flow cycle and the pressure or range of pressure in the gas cell during the cycle.

Evacuation cycle: The ACM 150 monitor starts each sampling cycle by switching the valves so that the Gas Cell Venturi Pump draws a vacuum on the gas cell. The inlet valve to the gas cell is shut off. This creates a large vacuum in the gas cell and efficiently removes the sample gas from the area just analyzed. While the gas cell is evacuated, the Boost Pump draws the sample air from the next area to be scanned, and its flow is diverted to bypass.

Surge cycle: The Gas Cell Venturi Pump continues to draw on the gas cell, but now the inlet valve to the gas cell is opened. This allows a surge of new sample from the Boost Pump into the gas cell. This replaces sample from the last area scanned with fresh sample from the current area.

Fill cycle: The valve to the Gas Cell Venturi Pump is shut and the gas cell fills with the new air sample until it reaches atmospheric pressure. The gas cell is allowed to equilibrate to atmospheric pressure before analysis begins. The calibrations for the measured components, used to develop the analytical methods, are all done at atmospheric pressure. If the analysis were not done at atmospheric pressure, the results would not be accurate.

Analyze cycle: The valves on the inlet and outlet of the gas cell are closed. The FTIR analyzer collects the infrared spectrum of the current air sample and sends it to the computer, where the data is extracted from the spectrum and reported as gas concentrations.

This sequence is automatically repeated for each area sampled on a continuous 24 hours cycle. It is only interrupted by Background scans or when the ACM 150 monitor is no longer in automatic mode.

Bypass and order of scan

When the air sample from an area is being analyzed by the ACM 150 monitor, the corresponding sample area number and name are displayed in the status bar on the touchscreen.

As soon as the Analyze cycle begins, the sample valve for the next area in the scan sequence opens. The Boost Pump draws the sample from that next area and bypasses it to exhaust (S1 opens). The purpose is to ensure that the internal tubing

has been thoroughly purged of the last sample and replaced with a fresh sample.

As the ACM 150 monitor samples and analyzes areas, another bypass flow continues for all areas not currently sampled. This flow is drawn through the Sample Valves by the Bypass Venturi Pump. The flow rate is controlled and balanced by a flow control orifice located in each Sample Valve. This assures a continuous flow through all of the sample tubes to maintain fresh, representative samples of air.

The user may program the sample Areas to be analyzed in any order, and even have some of the Areas analyzed more than once per complete scan cycle. This is determined by the Order of Scan. Some areas may also be scanned in groups, known as Composite Sample Groups. This is done to accelerate the scan cycle. Refer to [Setup Menus](#) for more information.

Background cycle

In order to sustain a permanent calibration for all monitored chemicals, it is necessary to periodically establish a baseline reference for the infrared spectrum. This is done by taking a Background or reference spectrum. This spectrum must not contain any of the measured chemicals. In fact, it should be free of infrared absorbing gases to the extent that it is practical. For that reason Background gas is nitrogen.

Once the Background spectrum is taken, the spectra collected for each analysis (the “scans”) are compared to the latest Background. If the air samples were exactly the same as the Background gas, the result would be a flat baseline along the x-axis of the ratioed spectrum. But, the gases are never exactly the same, because the air samples always contain some infrared absorbing gases, such as water vapor and carbon dioxide. The water vapor in the air will always be higher than the water vapor in the Background gas (it must be in order for the analysis methods to work properly). The peaks in the analysis spectrum contain the absorbance peaks of the chemicals present in the air sample. This includes the normal gases in the air, any measured chemicals which are currently present in the air sample and any other chemicals that exist in that air sample (“chemical strangers” with unknown odors, etc.). The analysis spectrum compared to the Background spectrum results in the absorption “fingerprint” of all chemicals present in the air samples. This is the spectrum used for analysis by the analytical methods.

Valve switching and timing

ACM 150 flow cycles identifies the valves energized during each cycle. The flow schematic for these valves, including Sample Valves 1-10 and Sample Valves 11-20, 21-30 and 31-40 may be obtained on request. All valves are shown in the de-energized state. For 3-way valves, the de-energized state is C—common to NO—normally open, which changes to C—common to NC—normally closed when the valve is energized. The 2-way valves are normally closed, and energized to open.

The typical timing and pressure readings for the various modes of operation with the 5 meter gas cell are:

Table 1. Cycle timing and readings

MODE OF OPERATION	TIME IN SECONDS (typical)	GAUGE READING (inches of mercury)
Evacuate	1-2	20-30 vacuum
Surge	3-4	5-15 vacuum
Fill	0.5 to 1	increases to 0
Analyze/Bypass	6-8	stays at 0
Background Purge	30-60	
(once every 2 hours)	stays at 0 or slightly positive	
Background Analysis	30-60	stays at 0

If you observe the Cycle Valve Control Panel, you can follow the modes for each area scan. You can also observe this on the local or remote computer screen by selecting View Cycle Valves.

The timing is set by the Honeywell Analytics service engineer in the configuration software. These times may be increased or decreased to get good sampling and analysis results in the minimum amount of time. Both the timing and the frequency of the Background mode may also be changed in the configuration software.

CDA panel

The panel shown below sets and controls the pressure of clean/dry air (CDA). It splits to two air set regulators, one for the Venturi Pump air supply and one for Line Leak Test.

Solenoid valve S9 is normally opened to supply air to drive the two Venturi Pumps. It shuts off automatically when the Backup Exhaust Pump takes over and is manually reset to open. The venturi regulator is set to 65-70 psig. If the Venturi option is used, the line leak regulator is set to approximately 15 psig when the test is active. The needle valve provides a flow restriction so that each line decreases approximately to 0 psig and increases for each tested line as it holds the pressure, as indicated on the gauge. S10 is closed except during the test mode, when it remains open.



Figure 20. CDA panel

1. Line Leak to Sample Rail
2. Line Leak Gauge
3. Line Leak Needle Valve
4. CDA In
5. To Venturi Pumps
6. Line Leak and Venturi Regulators/Gauges
7. Isolation Valve S9 / Solenoid Valve S10 / Solenoid Valve

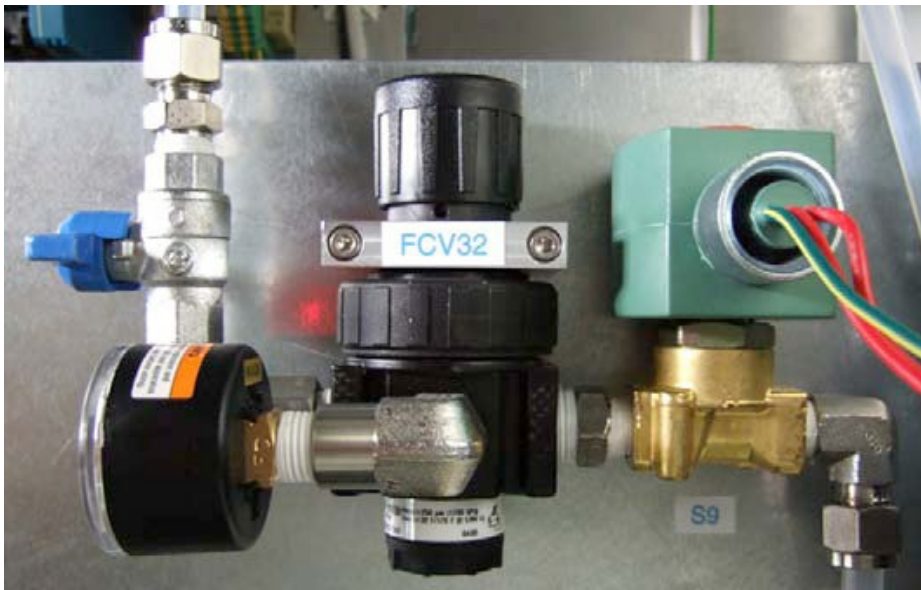

Figure 21. Venturi Supply (Option)

Other sampling components

Filter

A polypropylene filter is installed on the outlet of the Boost Pump. It helps keep the gas cell clean by removing particulates down to 0.1 microns.

Gas cell pressure gauge

A gauge mounted onto the top of gas cell indicates vacuum to positive pressure, calibrated in inches of Hg (mercury). This gauge can confirm the Sample Pressure scale on the Cycle Valve Control Panel, [Figure 7](#).

Absolute pressure transducers

The pressure scales on the Sample Valve and Cycle Valve Control Panels are the outputs of absolute pressure transducers. They measure both sample and bypass pressures. The computer uses these readings for multiple purposes:

- Identify a plugged sample line or an internal flow restriction
- Determine when the Backup Exhaust Pump is needed
- Optional Line Leak Test pass or fail

In-line sample filters

HA supplies the initial set of inline filters, one for each sample port on the ACM 150 monitor (from 10 to 40). The filters are installed near the sample inlet. They prevent a build-up of particulates in the tubes and protect the flow control orifices in the Sample Valves. The valves can become plugged and flow can be restricted if particulates are not filtered.

NOTE

An inline filter must be installed on every uncapped sample port to protect it, even if the filter is locally mounted at the inlet tie point on top of the ACM 150 monitor. Checking and replacing filters is required during periodic service.

Optional capabilities

The following options can be included with or added to any ACM 150.

Sample points

The ACM 150 monitor can be purchased with 10, 20, 30, or 40 sample points. There is a maximum of 40 sample points.

Automatic line leak test

Sample tube integrity must be confirmed whenever a new tube is installed. A leak test can be done using compressed air. Honeywell Analytics recommends using a test gas to confirm that the tube is connected to the correct port and that it is not diluted by outside air leaking in. After tubes are installed and tested, it is still possible to develop a leak in one of the sample tubes connecting the ACM 150 monitor to a sample point. Tube leaks can develop for various reasons, such as:

- disconnected at the sample point or at the monitor and not reconnected
- disconnected and reconnected but not properly seated or tightened
- accidentally cut by a contractor working in the facility

The automatic Line Leak Test is built into all ACM 150s, however, it may be turned on or off in the configuration by Honeywell Analytics. For every sample line in use, the test requires a check valve installed near the sample tube inlets, which is shown in the flow schematic that's available on request. The check valve passes flow in one direction only. It stops the flow of CDA coming from the ACM 150 monitor during the line leak test. This allows the entire sample tube to be pressurized. To eliminate particulates, an in-line filter is installed between the check valve and the inlet of each sample tube.

These check valves are available from Honeywell Analytics. They are SS check valves with 3/8 inch tube fittings and a cracking pressure of 1/3 psi.

If employed, automatic line leak is activated once a day at any time. CDA is directed down each sample tube, one at a time. If the tube holds pressure, it passes the test. If a tube fails to hold pressure, it fails the test and the ACM 150 monitor displays a malfunction message on the touchscreen.

ACM 150 operating principle

Basic operation

The ACM 150 monitor can provide qualitative identification and quantitative analysis of the chemicals in their gaseous state. Each time the ACM 150 monitor scans an air sample, it collects multiple spectra of that sample, typically 8 or more. The FTIR spectrometer takes about 1.2 seconds to collect a single scan. The spectra collected for each air sample are averaged, and the resulting spectrum is what the ACM 150 monitor uses to analyze the air sample.

Except for the few chemicals that do not absorb infrared radiation, the vapor phase of every chemical has a unique absorbance spectrum. An absorbance spectrum is a plot of absorbance on the y-axis and wavenumber on the x-axis. Wavenumbers are expressed as cm^{-1} because the wavenumber is the inverse of wavelength in centimeters. These spectra cover what is known as the mid-infrared or fingerprint region of the infrared spectrum.

The air sample spectra collected by the ACM 150 monitor contains all of the identifying absorption peaks of the gases that make up that air sample. However, the ACM 150 monitor will only report the gases that are set up as active for that sample area.

Wavenumber precision

The wavelength location of any chemical's absorbance peaks is fundamental and never changes, being fixed by the quantum mechanics of the molecule. The FTIR analyzer is able to reproduce the exact wavenumber location for each gas.

Absorbance and gas concentration

Absorbance is the extent to which the intensity of a beam of infrared radiation is decreased on passing through a sample of air in the ACM 150 monitor's gas cell. Transmittance is an expression of the intensity (or "radiant power") of the beam of infrared radiation passing through the same sample of air. If no gases are present at a given wavenumber, the transmittance is 1.0 or 100% and the absorbance is 0. The relationship between absorbance (A) and transmittance (T) is expressed as: $A = -\log T$. Absorbance, as defined by the Beer-Lambert Law, is directly proportional to the concentration of the absorbing chemical (provided other key variables are held constant), while transmittance is not directly proportional.

Therefore, absorbance

is used as a basis of measuring the concentration of gases present in the ACM 150 monitor's air samples. Variables other than concentration that effect absorbance are:

- Path length of the sample cell
- Resolution of the FTIR analyzer
- Temperature and pressure of the sample
- Non-linearity of the direct proportional relationship
- Characteristics of a particular FTIR analyzer and gas cell

Permanent calibration

Controlling variables

The ACM 150 monitor eliminates or minimizes these variables so that their effects on calculating the concentration are insignificant, in the following manner:

- The path length is fixed, e.g. at 10 M or 5 M. All reference calibrations and analyses are adjusted in your ACM 150.
- The resolution of the FTIR analyzer is set at 4 wavenumbers and all reference calibrations and analyses use the same 4 wavenumber resolution. The FTIR analyzer resolution can be changed, but it will cause error messages if operated at a resolution other than 4 wavenumbers.
- Temperature and barometric pressure changes have a small effect on the gas concentration and may be ignored without affecting accuracy of the ACM 150 monitor. In this installation, the temperature should be nearly constant in an indoor office-type facility. A cell heater should be added if there is a wide fluctuation. The potential effect of changes in the absolute “gauge” pressure of the sampled air is greater than temperature changes.

All reference calibration spectra are collected at 0 psig or 14.7 psia (1.0 atmospheric pressure). The ACM 150 monitor uses an absolute pressure transducer to assure that all analyses are done at 0 psig (14.7 psia).

- The relationship between concentration and absorbance becomes increasingly non-linear as the concentration increases and approaches saturation (which is 0% transmittance).
- As the concentration increases from, for example, 300 ppm to 1000 ppm the non-linearity increases and the accuracy of the reading decreases. The non-linearity varies for each chemical, for each absorbance wavelength and with cell path length. For the weakest IR absorbing chemicals and long cell path lengths, the non-linearity may be insignificant over the range of 0-1000 ppm. For the strongest IR absorbing chemicals, readings over 100 ppm may be significantly non-linear and less accurate.

Use of the background spectrum

It is critical that calibrations taken on one ACM 150 are valid for computing accurate concentrations on any other ACM 150. In that way, calibration spectra are valid for all ACM 150s and older models as well. This is accomplished by using a reference (or background) spectrum to which each analysis spectrum is ratioed. In the ACM 150 monitor a reference spectrum is collected every 2 hours while the gas cell is filled with nitrogen that is void of any monitored gases. For the next two hours each air spectrum collected is ratioed to the latest reference spectrum. If the gas composition of the air were identical to the background, the result would be a flat line on the x-axis. All variables that effect the spectrum are cancelled in this manner, because each air spectrum has same characteristics as the reference spectrum.

This cancels the effects of drift of the FTIR detector, IR source intensity changes, reduction of IR radiation in the gas cell as particles accumulate, etc. Each of these variables change slowly and has no effect on the accuracy of the measurement over a two hour period. This has been verified over years of application experience.

With “instrument error” cancelled by the background reference, the only factor effecting the amount of absorbance at any wavenumber is the concentration of the vapor phase chemical that absorbs at that wavenumber. If no gas is present, the absorbance will be 0, i.e. a flat line on the x-axis. If the gas is present, it will absorb in direct proportion to its concentration.

The units of absorbance (A) are divided into milliabsorbance (mA) units, where $1000 \text{ mA} = 1.0 \text{ A}$. When we calibrate for a chemical and collect that calibration spectrum, we are determining the number of milliabsorbance units per ppm of gas concentration for each wavenumber region where that chemical absorbs IR radiation. Or, if the ACM 150 monitor has a 10 cm cell for % LEL/LFL ranges, the relation may be expressed as milliabsorbance units per % concentration.

Analytical methods

Methods development

A method is a combination of individual calibration spectra for a group of chemicals. When we develop a method, we pre-select the absorbance peak regions that will be used to first identify and then quantify each chemical. A few chemicals have only one usable absorption peak, while many have six or more usable peaks. The average is three usable peaks for qualitative screening and for quantitative analysis.

For each absorbance peak region of each monitored chemical in a method, the relationship between milliabsorbance units and concentration (usually in ppm) is entered into a p-matrix that is used to compute the concentration of each gas in all new and unknown air spectra collected by the ACM 150 monitor.

Sometimes chemicals within the same method have absorbance peaks that overlap in the common peak regions. In the simplest expression of the Beer-Lambert Law, the resulting absorbance peak is the sum of absorbances of the over-lapping peaks from each chemical. The matrix uses more calibration data sets from other wavelength regions to improve on this computation.

The computation accuracy is further improved by the use of advanced data fitting statistical techniques, known by the broader term of Chemometrics. The technique of PLS (partial least squares) is employed in the ACM 150 monitor to fit a data set from the unknown air spectra to the “training” set in the method.

The relationship between the various peak heights in milliabsorbance units and the ppm concentration is determined and becomes the basis for quantitative identification of unknown air spectra.

To confirm that the methods correctly identify and accurately measure the concentrations of their chemicals, the methods are tested using calibration spectra. This simulates the analysis of unknown air samples using the methods developed to measure the chemicals of interest.

It proves that the methods correctly identify and measure all of those chemicals, and it is a valid test of the calibration accuracy.

Of special interest is the ability of the ACM 150 monitor to identify and measure these chemicals at the alarm set points. Since the reference calibration spectra were not collected with these set points in mind, the concentrations are not the same. Nevertheless, the magnitude of the absorption is directly proportional to the chemical concentration, and the wavenumber region of every absorption peak is fixed. Therefore, spectra of the chemicals at any level of milliabsorbance units, including the set point level, will be read accurately. This can be confirmed by introducing any chemical at or near the set point level in your ACM 150.

Your Methods - Chemicals Monitored by Your ACM 150

The ACM 150 monitors the air samples for the presence of gases and the vapors of liquid chemicals. It will monitor only those chemicals for which it has been configured. The ACM 150 monitor is always provided with at least one analytical methods, although several analytical methods may be used. These are the chemicals that were requested by the user and then grouped by an Honeywell Analytics application chemist into methods or groups of chemicals.



The method is identified with a customer code at the beginning followed by the method number. Each time it is revised to add or delete gases the method number is changed.

The user can assign any of these methods to a particular sample area. Once a method (group of chemicals) is selected for a sample area, the user must then decide which of the chemicals contained in the method may actually be present at the sample area. Those chemicals are selected as active.

The ACM 150 monitor will then monitor each sample areas for the all of the chemicals set active for that sample area. Chemicals designated inactive are not reported by the ACM 150 monitor.

ZPD Value and Location

The ZPD, Zero Path Difference, is a signal that is produced by the FTIR analyzer. The value and location of the ZPD are performance indicators which are always monitored by the ACMs computer.

ICON KEY	
	Authorized Users
	Trained Technician

Installation environment**Space requirement**

No access is required from the rear or from either side. The ACM 150 monitor may be against a wall or set back-to-back with another monitor. Allow a space of 3 inches (8 cm) behind the rear for air circulation. Front access is required. Leave a clear space of 36 inches (91 cm) in front of the cabinet door.

The approximate overall dimensions of the cabinet are:

- Height: 60 inches (152 cm)
- Width: 40 inches (102 cm)
- Depth: 26 inches (66 cm)
- Weight: 800 pounds (363 kg)

Temperature and protection

Install indoors in a heated and air conditioned environment. The recommended temperature range is 60 to 85 °F (15 to 30 °C). The standard cabinet is designed to meet an IP 20 rating.

Electrical area

The ACM 150 monitor is designed to be located in a non-hazardous or general purpose electrical area. Refer to Technical Specifications on page 97.

Utility requirements

The ACM 150 monitor requires the following utilities:

- Line power: 115V 60Hz 13 Amps or 230V 50Hz 6 Amps (setup at factory)
- Normal idle power consumption: ~8 amps @ 115 VAC
- Average power consumption: ~14 amps @ 115 VAC
- Peak power consumption: ~20 amps @ 115 VAC
- Clean, Dry Air (CDA): 90 psig, 12 SCFM, 3/8 inch OD tube
- Nitrogen: 5 psig, ~8 liters/minute, 1/4 inch OD tube
- Exhaust: 15 cfm, 1-1/2 inch OD tube
- Main supply voltage: $\pm 10\%$ of nominal voltage
- Overvoltage: Category II

Vacuum sampling system

The ACM 150 monitor samples up to 40 areas, which are scanned and analyzed in sequence, as described in Air sampling system. The main assemblies are:

Bypass Venturi Pump	Draws flow through sample tubes and bypasses the flow to exhaust to provide a constant flow of fresh sample to the monitor
Gas Cell Venturi Pump	Evacuates the sampled air from the gas cell after it is analyzed
Boost Pump (mechanical)	Fills the evacuated gas cell with fresh sampled air for each analysis cycle
Sample Valve Assembly	Valves installed in the 10-port sample manifolds (up to 40) that switch in sequence as the ACM 150 monitor scans the sample areas
Cycle Valve Assembly	Group of 6 valves that control the flow through the gas cell
Backup Exhaust Pump	Normally idle, this mechanical pump backs up the venturi pumps to provide operation in the absence of CDA

Available outputs

The following output relays are dry contact, double-pole/double-throw (DPDT), rated for 3 amps @ 30 VDC

Programmable Output Relays (80)	<p>Default programmable relay settings</p> <ul style="list-style-type: none"> Relays 1-40 activate for any gas at the Alarm 1 level set point for areas 1-40 Relays 41-80 activate for any gas at the Alarm 2 level set point for areas 41-80 <p>The default settings for each relay may be changed by the user to activate</p> <ul style="list-style-type: none"> At the Alarm 1 or Alarm 2 level For any gas, for all gases or any selected group of gases At any area, all areas or any selected group of areas
Additional Output Relays (6)	<ul style="list-style-type: none"> Power fail Watchdog timer Manual Mode General malfunction General warning General alarm

Data interface and protocol

Network	Ethernet
Protocols	TCP/IP webserver
Optional Driver	OPC (OLE for Process Control)

Other communication networks are available. Contact Honeywell Analytics for more information.

ICON KEY	
✓	Authorized Users
🔧	Trained Technician

Receipt and unpacking

ACM 150 systems and parts may be shipped in one or more containers. Each packing slip indicates the number of crates. Report any signs of rough handling or damage during shipment to the transportation carrier. Inspect all equipment and/or parts after removal from shipping containers.

NOTE

Report any broken, damaged, or missing parts immediately to Honeywell Analytics or your local Honeywell Analytics representative.

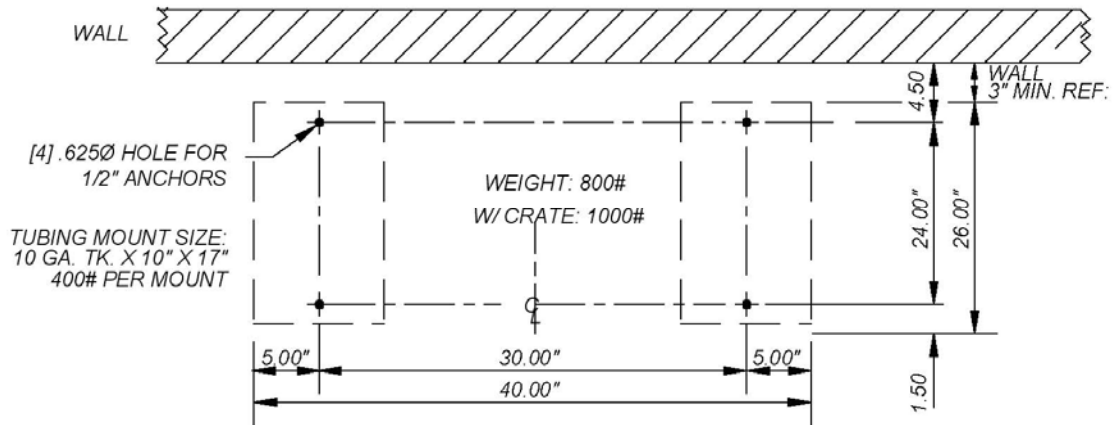

Figure 22. Floor Mounting Locations

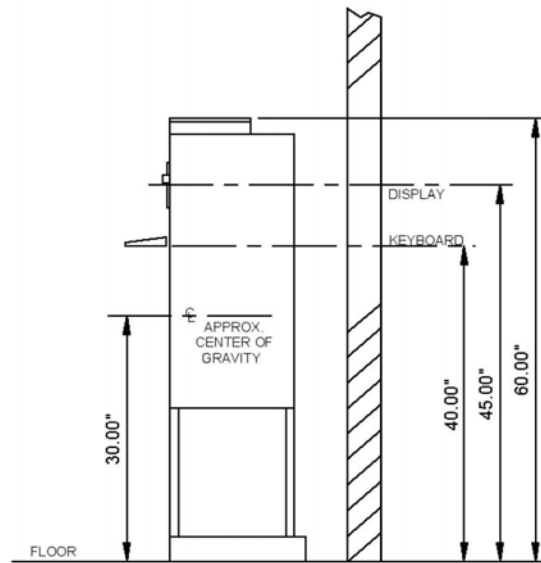

Figure 23. Ergonomics

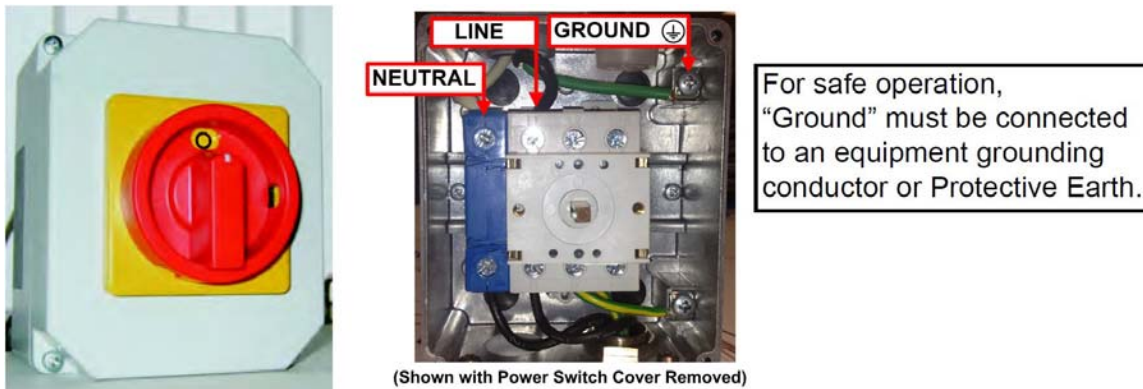

Figure 24. Main power switch and supply connections

NOTE

For safe operation, Ground must be connected to an equipment grounding conductor or Protective Earth.

DANGER!

Electrocution danger. Before removing the Main Power Switch cover or connecting line power, verify that the external AC supply power is disconnected at the source in accordance with your company's Lockout/Tagout procedures.

DANGER!

Dangers d'électrocution . Avant de retirer le couvercle de l'interrupteur d'alimentation principale ou de brancher l'alimentation de la ligne , vérifiez que le bloc d'alimentation secteur externe est déconnecté à la source conformément aux procédures de verrouillage / étiquetage de votre entreprise

Emergency Power-Off (EPO) option

Some facilities require that equipment, like the ACM 150 monitor, have an EPO (or panic) switch. The user can add an EPO switch between the external breaker/switch and the Main Power Switch.

NOTE

The ACM 150 monitor is a life-safety monitor that is intended to operate under virtually all conditions. An EPO switch is not generally recommended, because unauthorized personnel might push it and take the ACM 150 monitor off-line when it should be on-line.

In the Off position the Main Power Switch disconnects AC line power from all internal parts and assemblies.

Lockout/tagout (LOTO) disconnect

Integral LOTO

CE safety standards require the AC power line to be hard-wired inside conduit through a Lockout/Tagout disconnect. The Main Power Switch, [Figure 24](#), provides this LOTO disconnect. A key lock may be added when it is switched to the Off position.

External LOTO

An external LOTO power disconnect is necessary only when the power terminal strip located inside the Main Power Switch is accessed. The appropriate LOTO method depends on the AC wiring option that is used. Follow your company procedures or, if none are established, follow these recommendations for circuit breaker or fused disconnect box: turn the power off at the box, and then close it and lock it, typically using a padlock.

International line power

The ACM 150 monitor will operate at either 50 Hz or 60 Hz, single phase power. If your line power is not within the range of 110-115 VAC, advise Honeywell Analytics prior to placing an order. The ACM 150 monitor can be set up at the factory to operate on AC power in the range of 200-230 volts AC. Appropriate sizing of the external circuit breaker is the user's responsibility.

Isolation transformer

The ACM 150 monitor is internally protected against voltage spikes and power fluctuations. If your line power quality is poor and/or subject to severe spikes or lightning strikes, an external isolation transformer (2.0 KVA) should be installed to protect the monitor. This is unnecessary if the ACM 150 monitor connects to a UPS.

Maintaining AC power

Most users want the ACM 150 monitor to continue to operate when line power is interrupted. The monitor may be wired to either a UPS, Uninterruptable Power Supply, or to an Emergency Power source.

Utility gases and exhaust piping

Nitrogen supply

The ACM 150 monitor requires a constant supply of nitrogen, which is used as a dry purge gas for the optics bench and as a zero gas for the Background cycle. The requirements are:

Source	plant bulk nitrogen supply or N ₂ cylinders
Quality	99.9% or better
External Pressure Regulator/Shut-off	located near the ACM 150 monitor (by installation contractor)
Delivery Pressure	set external regulator to 5 psig (0.35 kg/cm ²)
Connection	1/4 inch tube fitting (per Figure 25)
Consumption	less than 8 liters/minute, intermittent

Air supply

Compressed air is required to operate the venturi pumps. It is also used for the optional Line Leak Test:

Source	clean, dry compressed air (CDA) or instrument-grade air
External Pressure Regulator/Shut-off	locate near the ACM 150 monitor (by installation contractor)
Quality	filtered and oil-free with a dew point of -20°F (-29°C)
Pressure	65-70 psig set on the internal regulator (included)
Connection	3/8 inch tube fitting (per Figure 25)
Consumption	venturi pumps 12 scfm (340 lpm)

CAUTION!

High pressure air is used inside the venturi pumps and can be hazardous. Shut off the air supply and verify that no stored pressure is present before servicing the venturi pumps.

MISE EN GARDE!

L'air à haute pression est utilisé à l'intérieur des pompes venturi et peut être dangereux. Fermer l'alimentation en air et vérifier qu'aucune pression stockée est présente avant l'entretien des pompes à venturi.

Exhaust

The ACM 150 monitor exhausts the air it samples through an exhaust pipe located on the top. Connect this to an exhaust duct with no flow restriction that is compatible with the types of gases monitored by the ACM 150 monitor. The requirements are:

Flow Rate	12 scfm (340 lpm)
Connection	1-1/2 inch male pipe thread (per Figure 25)

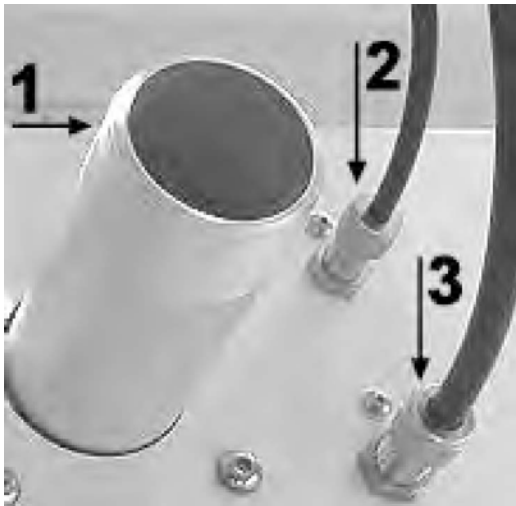

Figure 25. Nitrogen, CDA and exhaust connections

- 1. Exhaust Pipe
- 2. Nitrogen
- 3. Air (CDA)

NOTE

Vent the monitor’s exhaust properly in accordance with site or legislated safety policies governing the gases being monitored, workplace safety, and environmental requirements

Sample tubing and filters

Tubing material

Tubing is used to connect the ACM 150 monitor to the monitored sample points. The requirements for tubing are:

Size	3/8 inch O.D. by 1/4 inch I.D.
Recommended Material	PFE Teflon, 500 foot rolls
Alternate Material	Polypropylene, such as Parker PP-64 (500 foot roll) or equal quality. Polypropylene is acceptable for most gases that are not reactive (not suitable for mineral acid gases)
Unacceptable Tubing NOTE If metal tubing is required by fire code, use 316 SS tubing or run Teflon or polypropylene in metal conduit. Before using SS tubing, consult with Honeywell Analytics about material compatibility.	<ul style="list-style-type: none"> • all other plastics • all other metals • tubing with a smaller OD than 3/8 inch • thin wall tubing that can kink when bent

CAUTION!

Tygon, polyethylene, copper and aluminum absorb or react with many gases. Use only the materials listed above. Make no substitutions.

MISE EN GARDE!

Tygon , le polyéthylène, le cuivre et l'aluminium absorbe ou réagir avec de nombreux gaz . Utilisez uniquement les matières énumérées ci-dessus . Ne faites pas de substitutions .

Tubing run lengths

The ACM 150 monitor should be located near the areas it samples to minimize tube lengths and response time. The maximum distance for tubing is 750 feet (230 meters) or 500 feet (150 meters) when composite sampling mode is used. Prevent leaks in sample tubes by making continuous runs with no fittings or unions, if possible. Discard short lengths that are left over instead of joining them to make longer runs.

ACM 150 tube connection points

Each sample tube is connected to an inlet on top of the ACM 150 monitor using 3/8 inch Swagelok tube fittings. The inlet fittings are numbered from 1 to 40, as shown in [Figure 26](#).

Sample area connections

NOTE

The buyer is responsible for deciding which areas and gases to monitor and the exact location of the sampling points in gas cabinets, storage rooms, valve boxes, exhaust ducts, exhaust hoods, breathing zones, etc. Honeywell Analytics does not determine and cannot advise the exact point to sample for hazardous gases. The buyer, the equipment manufacturer or a third party consultant must make such decisions.

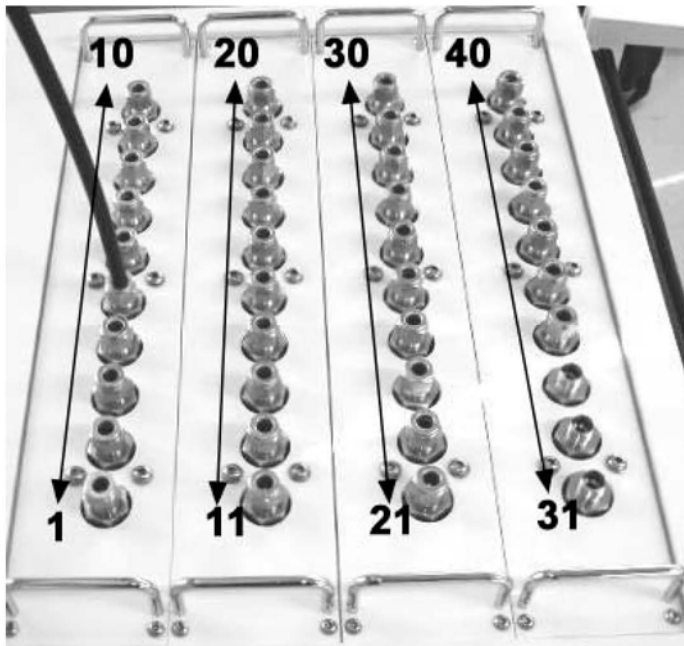

Figure 26. ACM 150 Tube connection points

Points and gases monitored

The ACM 150 monitor is designed for and intended to detect occasional leaks of hazardous gases at levels that are within its range of detection. The following conditions may harm the ACM 150 monitor and may violate the warranty terms:

- Continuous presence of oxidizing or corrosive gases at one or more sample point at levels exceeding 10 PPM, particularly if the air is humid.
- High PPM level leaks that saturate the ACM 150 monitor with oxidizing or corrosive vapors.
- Liquids (water, solvents or oil) present in the sampled air that enter the ACM 150 monitor via the sample tubing.
- Flammable gases above explosive levels that might increase the risk of fire inside the ACM 150 monitor.

The ACM 150 monitor is not suited for monitoring samples that contain high levels of corrosive and/ or condensable gases, such as the exhaust from treatment systems.

Application suitability and adaptability

Honeywell Analytics provides a list of typical gases for the ACM 150 monitor and

its other gas detection products. The list also identifies limitations. Before you can use the ACM 150 monitor as a monitor, an Honeywell Analytics applications chemist must provide the software, or analytical methods. This requires an applications review, where suitability can be verified. The ACM 150 monitor has an enormous capacity for monitoring gases. It can accommodate changes in the gases it monitors. Ask Honeywell Analytics about the detectability of gases you need to monitor.

Record keeping

It is critical that an accurate record be maintained, correlating each ACM 150 sample point number to the name for the location of the monitoring point to which it connects. A form to record those numbers and names is provided in Form 1 on page 59.

Each sample line must also be numbered with the connection point it is associated with. It is also highly recommended that each line also be identified with a location. This identification is necessary so that sample lines can be safely disconnected and then later replaced correctly during maintenance and service procedures.

Filters, check valves and probes

In-line filters

The ACM 150 monitor requires a filter at the inlet of each sample line to protect the tubing and internal sampling system from an accumulation of particulates. Honeywell Analytics supplies one filter for each sample port. Install the filters at the sample pick-up point when the tubing is run to each port.

If a port is not currently used, leave the cap over the inlet tube fitting. If there is no cap, install a short run of tubing with the filter at the inlet. This keeps particulates out of the bypass orifice which draws all on ports, used or not.

Check valves for line leak test (optional)

The ACM 150 monitors have the capability to perform an automatic Line Leak Test, however, not all users may want this feature. To implement it, check valves must be purchased and installed, one per sample port. They may be included with the original order for the ACM 150 monitor, or they may be added later.

The check valves allow flow to pass through to the tube inlets to each ACM 150 monitor sample port. They seal off when air flows in the opposite direction during the Line Leak Test. This causes pressure to build up in the sample tube. A tube that fails to hold pressure has a leak.

The check valves must be installed at or very near the inlet of each sample tube with the inline filters installed between the tube inlet and check valve. The inline filters also keep the check valves clean so that they will seal tightly during the Line Leak Test.

Locating the filters and check valves

The inline filters require periodic replacement, and the check valves may require occasional disassembly and cleaning. Try to locate both items where they are easily accessible.

Wiring the outputs

Access plates

[Figure 27](#) shows two access plates on top of the ACM 150 monitor. They are provided for wiring the outputs. Remove one or both plates and cut or drill, as necessary to accommodate your preferred connection, such as:

Flange	mating to Wiremold or similar raceways
Wiring Hubs	to connect to electrical conduit



Figure 27. Output wiring access panels

Relay output wiring

All 86 relays on the Relay Output Board have plug-in connectors. Remove the connectors and wire to them outside of the monitor. Then, plug them into the board. The connectors have 6 terminals accommodating 18 AWG or smaller wire. The relays are numbered on the board, which is shown in [Figure 28](#).

Standard output relays

There are 80 programmable relays. They have a default setup providing 40 Alarm 1 level and 40 Alarm 2 level outputs for up to 40 sample areas. Each relay is independently programmable. The user can change configure set points, sample areas and gases in any combination or grouping.

Six status relays are on the Relay Output Board. They activate when service request or malfunction incidents are detected by the ACM 150 monitor or when power is lost.

It is highly recommended that these relays be connected to a continuously monitored alarm system. These relays provide a verification of alarm conditions and operational status that is separate from all other alarm outputs. They can provide important information, if other communications links fail.

Relay terminals and activation options

Relay terminals

Since the output relays are DPDT, they may be connected to two separate devices, and each device can have a separate DC or AC power loop, wired through the common (labeled COM) terminals. Each set of terminals provides the choice of wiring to the normally open (NO) or normally closed (NC) contacts. Since the relay state is NC when de-energized and NO when activated, most users wire to the NO terminals. However, if your control logic allows you to trip on loss of signal, you can wire to the NC terminals. This has the benefit of alarming if a wire is broken or disconnected.

Fail safe configuration

The software can be configured to reverse the relay logic so all of the output relays are normally energized. You would wire to the NO terminals. An Alarm 1 or Alarm 2 condition, a broken or disconnected wire, or a failure of the relay would activate the alarm device, shutdown sequence and/or control logic for that relay. This is a fail-safe implementation, and it requires a change in the ACM 150 monitor software configuration by Honeywell Analytics.

NOTE

If you use the fail-safe configuration, all of the ACM 150 monitor output relays will activate on loss of power, which is likely to cause wide-spread alarms and gas shut-downs. Even a reboot of the computer will cause this to occur. It is essential that a bypass switch be utilized to maintain power in the wire loop so that the ACM 150 monitor can be shutdown for service or when loading new software.

Non-latching vs. latching configuration

The ACM 150 monitor output relays are non-latching in the standard configuration. This means that they reset automatically when the condition (alarms, malfunction, power loss) returns to normal.

The software configuration allows a change to latching relays. When the condition returns to normal, the latching relay contacts will remain activated. They can only be reset from the ACM 150 monitor touchscreen or via network remote computer. This is not recommended if you have latching relays in your control logic, because it would require a manual reset at two locations to silence alarms. However, if your control logic does not latch, i.e. holding the condition until manually reset, you should have the ACM 150 monitor configured with latching relays. This is especially important if the ACM 150 monitor alarm relays will directly activate automatic gas shutdown in your facility.

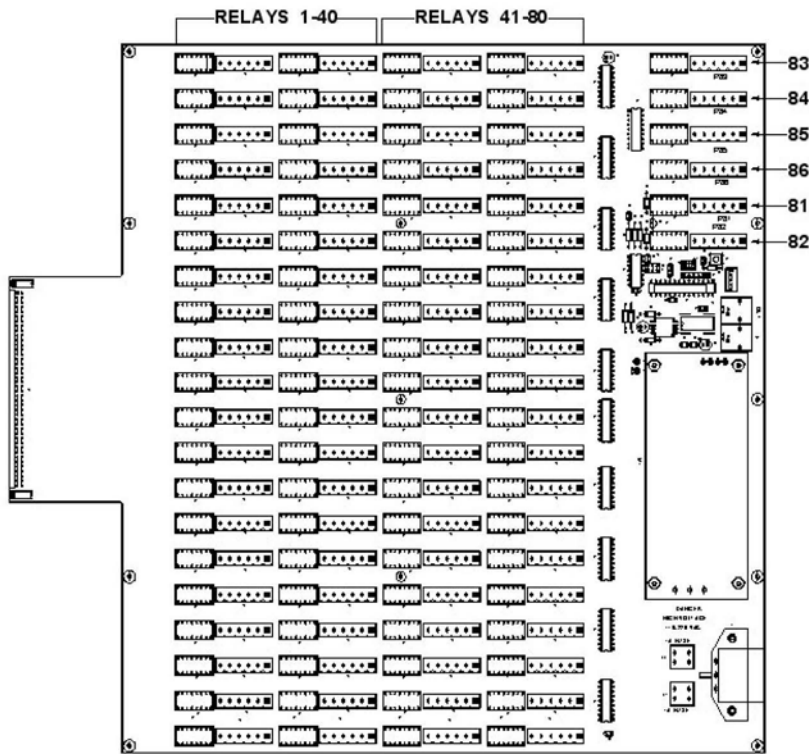

Figure 28. Relay output wiring

- 81 Power Fail
- 82 Watchdog Timer
- 83 Manual Mode
- 84 General Malfunction
- 85 General Alarm 1
- 86 General Alarm 2

WARNING!

This sequence can cycle repeatedly and may result in an exposure to toxic gas while ERT personnel are repairing the leak.

If the ACM 150 monitor output relays are used to shutdown the gas source and interrupt the gas flow, a latching relay must be used in the control loop. If not, the ACM 150 monitor relay will shutdown the gas source and stop the leak that was detected by the ACM 150 monitor. The alarm will soon clear and reset the relay, restarting the flow of gas, and the leak will be detected again.

ATTENTION!

Cette séquence peut à plusieurs reprises le cycle et peut entraîner une exposition à des gaz toxiques tandis que le personnel de l'EIU sont la réparation de la fuite. Si les ACM 150 relais de sortie du moniteur sont utilisées pour arrêter la source de gaz et interrompre l'écoulement de gaz , un relais de verrouillage doit être utilisé dans la boucle de commande . Si non, l' ACM 150 moniteur relais arrêt de la source et de gaz arrêter la fuite que a été détecté par le moniteur ACM 150 . L'alarme sera bientôt claire et réinitialiser le relais , le redémarrage de l'écoulement du gaz , et la fuite sera à nouveau détecté .

Data interface, Remote computers

Capabilities

The ACM 150 monitor operates and performs all of its functions as a stand-alone monitor. While it is not necessary to connect it to a remote computer, it is recommended. The remote computer can access all data, operations, setup selections and most of the test functions.

Interface

You can connect a remote computer to the ACM 150 monitor via the internet or local network. Authorized employees can then access the ACM 150 monitor from remote locations. If a local network is used, you may connect as many remote computers as you need to one or more ACM 150 monitors.

Sending stored spectra

The ACM 150 monitor saves the infrared spectra of its area scans. The remote computer can send the saved spectra to Honeywell Analytics via e-mail. These spectra provide a “fingerprint” of the air samples. They are often used to verify alarm incidents, and they can help identify unknown odors with the aid of spectral search software. Interpreting spectra, and using FTIR lab software and spectral search libraries requires special training. Honeywell Analytics application chemists are experts in this field and offer this service to their customers.

Networks

Direct questions concerning network interfacing to your Honeywell Analytics representative.

Interfacing to a PLC

Combining Relay Outputs and Remote Computer

If you are connecting the ACM 150 monitor to a PLC (Programmable Logic Controller) you can connect the relay outputs and/or the network. Many users connect only the relay outputs to the PLC so that ACM 150 monitor incidents trigger the desired control functions at the PLC automatically. They use a remote computer to access the monitoring data associated with the incidents.

Gas concentration data

Some users prefer to send gas concentration data to the PLC and use the PLC to read the data generated by incidents. This data may be sent via a network interface.

Ethernet interface

The ACM 150 monitor is designed to connect to a PLC via gateways. The ACM 150 monitor has an Ethernet interface and an OPC driver is available as an option. If you use this interface, all data is available to the PLC, i.e. the concentrations of all gases monitored on all ports.

Gateway Interface

The ACM 150 monitor can provide an optional built-in programmable gateway that can communicate with several different data protocols including many used in popular PLCs. Ask your Honeywell Analytics representative for information regarding your application.

Installation drawings

In addition to the drawings in this section, drawings may be separately provided to clarify the installation of special or modified assemblies.

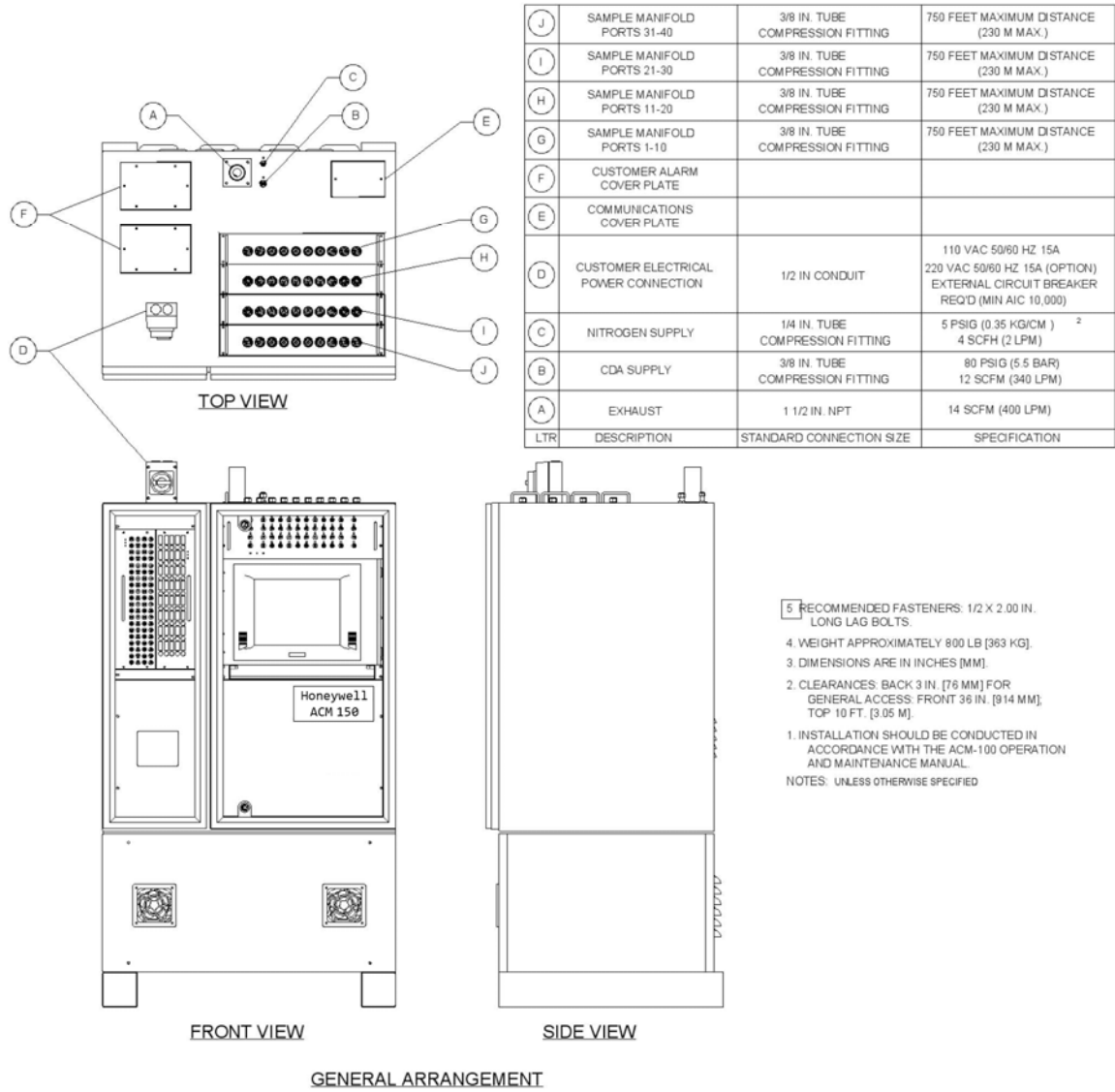

Figure 29. Installation diagram

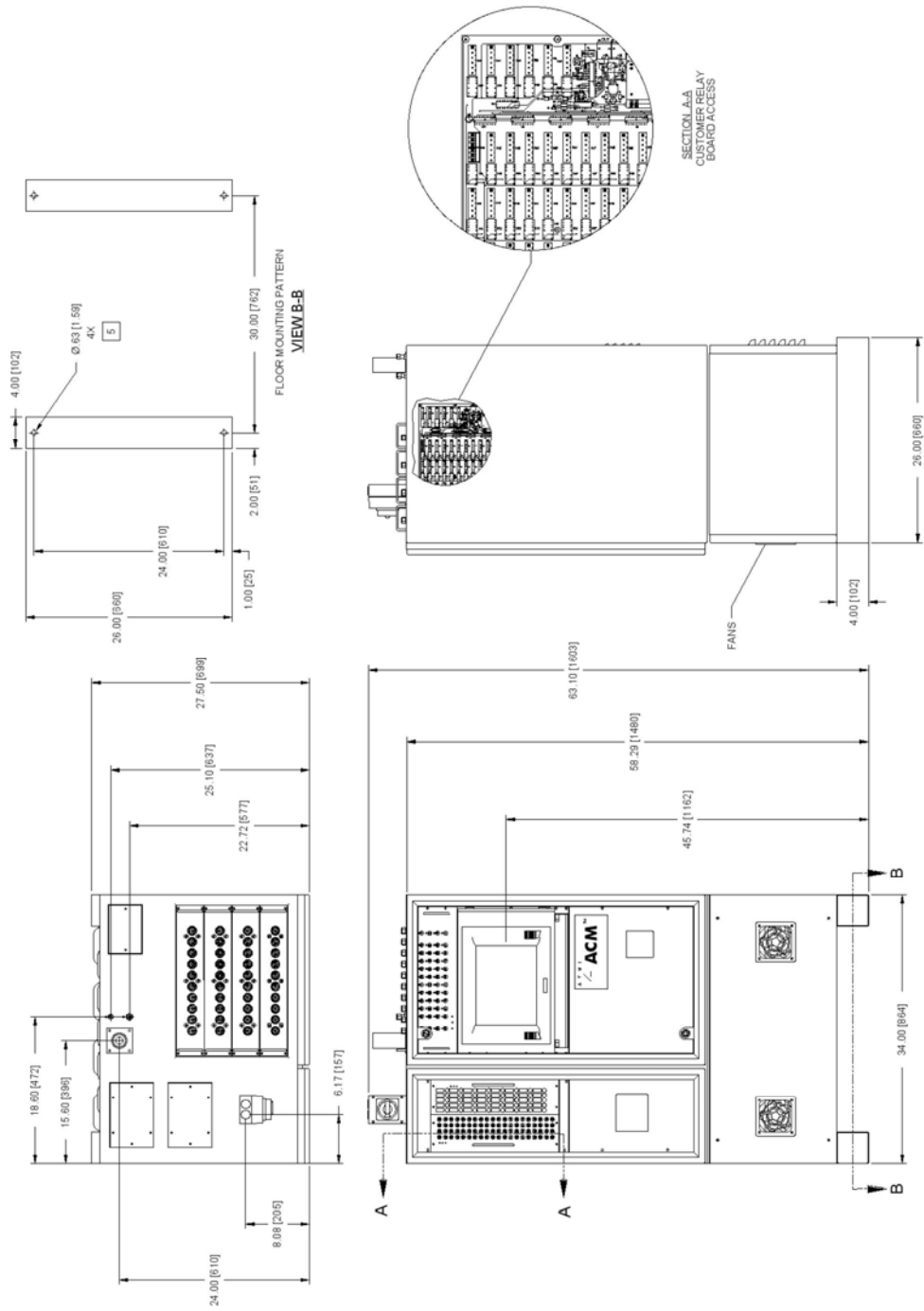



Figure 30. Installation diagram

Form 1: Sample point matrix

ACM 150 Port#	Gases Monitored	Sample Point Name or Equipment ID #	Installation Notes
1			
2			
3			
4			
5			
6			
7			
8			
9			
10			
11			
12			
13			
14			
15			
16			
17			
18			
19			
20			
21			
22			
23			
24			
25			
26			
27			
28			
29			
30			
31			
32			
33			
34			
35			
36			
37			
38			
39			
40			

ICON KEY	
	Authorized Users
	Trained Technician

Operation

Safe and proper operation of the ACM 150 monitor

ACM 150 operating safety

The ACM 150 monitor design ensures that the operator is protected from injury when using the front panel touchscreen, keyboard and push buttons. There is no danger to the operator when opening any of the doors or the outside panels on the ACM 150 monitor for inspection purposes. No internal plates, shields or components should be touched, tested, removed or serviced except by a Trained Technician. The user must read and follow all warning labels on the monitor and the highlighted CAUTION, WARNING and DANGER notes contained in this manual. The ACM 150 monitor is designed to comply with CE safety standards.

CAUTION!

Do not use RF-generating devices such as two-way radios or cellular phones within 10 M of the installed ACM 150 monitor.

MISE EN GARDE!

Avez dispositifs RF générant pas usée tels que les radios bidirectionnelles ou les téléphones cellulaires moins de 10 m de l' installée ACM 150 moniteur.

Laser and exterior label

Within the FTIR optics bench is a Class 1 laser. A laser-product label is displayed on the exterior door of the optics cabinet of the ACM 150 monitor.

Laser and interior labels

The front door of the Optics Cabinet may be opened without any danger of a direct exposure to the laser. The laser is installed inside the Perkin Elmer FTIR optics bench, and the laser light is contained within it. In the ACM 150 monitor configuration, the laser light does not exit from any aperture, and there is no danger of exposure to this laser radiation. Exposure to radiation from this laser is only possible under these conditions:

- The FTIR optics bench is physically removed from the ACM 150 monitor Optics Cabinet,
- The gas cell is removed while power is applied to the bench, and
- The bench is disassembled when power is applied.

DANGER!

High voltage AC power and laser source inside the FTIR optics bench can cause injury to eyesight or electrocution. Caution Labels have been applied to the FTIR optics bench by the manufacturer. Read and comply with those labels. Only trained personnel, including Honeywell Analytics service engineers, are qualified to open the FTIR optics bench and service the components inside with AC power applied.

DANGER!

Haute tension et le laser source de courant alternatif à l'intérieur de l'optique FTIR banc peut causer un dommage à la vue ou d'électrocution . Étiquettes d'avertissement ont été appliquées à le banc optique FTIR par le fabricant. Lire et se conformer à ces étiquettes . Seul le personnel qualifié , y compris des ingénieurs de services Honeywell Analytics , êtes- qualifié pour ouvrir l'optique FTIR banc et entretenir les composants à l'intérieur en courant alternatif appliqué .

Computer information

ACM 150 touchscreen and keyboard

When any entry requires alpha-numeric characters, use the keyboard.

Remote computer access

The ACM 150 monitor may be operated from a remote computer via network or Internet. All functions can be accessed remotely. The setup program is available to a remote user who has authorized access. Local users have priority and can logout remote users.

Status and scan results

Area scanning

Typically, the ACM 150 monitor operates in normal scanning mode. The display updates each time the ACM 150 monitor completes a scan of a sample area. A scan samples the air from that area, analyzes the sample and displays the results. The cycle time for each update depends upon the set up and configuration of the ACM 150 monitor. Typically, the scan rate is 15 seconds per sampled area. A longer scanning rate may be used to enhance lower detection sensitivity.

Background

Every two hours the ACM 150 monitor stops normal scanning and acquires a new Background spectrum. A message may display on the monitor while this occurs. After it the background spectrum is complete, normal scanning resumes automatically. The Background spectrum cannot be stopped. The operator must wait until the background spectrum is complete before changing operating modes.

Status bar

At the top of the ACM 150 monitor display is a status bar. It displays the current status, and it alerts the operator to any conditions requiring attention.



Figure 31. Status bar

Warn / Alarm 1/ Alarm 2 Status:

If there are no current alarm incidents, the display indicates No Alarm 1, No Alarm 2 and No Warn. When an incident occurs, the display changes to indicate the level.



Service Status:

When System OK is displayed, the ACM 150 monitor is operating normally without any faults detected. When a fault or a condition requiring service attention is detected, this display indicates a status change:



This display also shows when the ACM 150 monitor is off-line for servicing.



Operating Mode: [Figure 30](#) shows Automatic Mode as the current mode of operation, followed by 1: Area 1. This means the ACM is currently sampling and analyzing area (or sample point) #01 and that area has been named Area 1. When the scan of Area 01 is completed the details show as the Recent Scan Results ([Figure 32](#)), because this was the last area scanned. Every two hours, automatic scanning is briefly interrupted while a new reference is established. The display changes from Automatic Mode to Acquire Background.

The ACM 150 monitor operates in normal scanning mode or Automatic Mode unless it is taken out of that mode for test/service purposes. Manual and Frontpanel are test/service modes. When they are selected, normal scanning is interrupted, and the display changes from Automatic Mode to Manual Mode.

Recent scan results

Below is an image of Recent Scan Results. It updates as each area scan is completed, about every 15 seconds on a standard ACM 150 monitor. The display shows variables that are determined by the Setup program. These variables can be updated as conditions change (refer to [Setup Menus](#)).

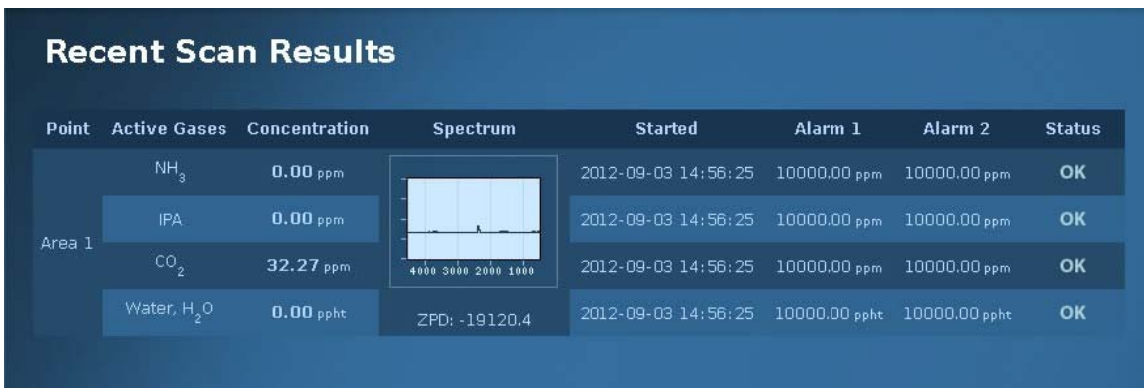

Figure 32. Recent scan

<p style="text-align: center;">Point</p> <p>NOTE Area Number, Port Number and Point Number all correspond to the inlet port number, 1 - 40, on top of the ACM 150 monitor. This is where the sample tube connects the ACM 150 monitor to the remotely sampled locations. Those sampled locations are always identified with the same 1 - 40 number, but they may be further identified using an area name.</p>	<p>This displays the name that the user designates for the sample area, corresponding to the area number. Since area number is unlikely to have any meaning to the operator, the ACM 150 monitor software allows you to enter the name or equipment ID #.</p>
<p>Active Gases</p>	<p>The gases actively monitored at that area. If a gas is not shown as active, it is not being monitored at that area</p>
<p>Concentration</p>	<p>Concentration of each active gas. Usually, the ACM 150 monitor confirms zero gas present, shown as 0. In most cases the scale is ppm (parts per million). Other concentration scales available are % LEL for combustible gases and ppht for water vapor (these terms are defined in Appendix C)</p>
<p>Spectrum</p>	<p>Infrared spectrum of this air sample. Selecting it expands the spectrum for viewing</p>
<p>Started</p>	<p>The date and time of the scan is identified</p>

Alarm 1	Alarm 1 level set point for this active gas.
Alarm 2	Alarm 2 level set point for this active gas
Status	<p>Status for each active gas on the display</p> <ul style="list-style-type: none"> • OK: Indicates the gas concentration is lower than the warn level set point. • Warn: Indicates the gas concentration is above LDL • Alarm 1: Indicates the gas concentration exceeds the Alarm 1 level but is lower than the Alarm 2 level. • Alarm 2: Indicates the gas concentration exceeds the Alarm 2 level set point.

Changing the mode of operation

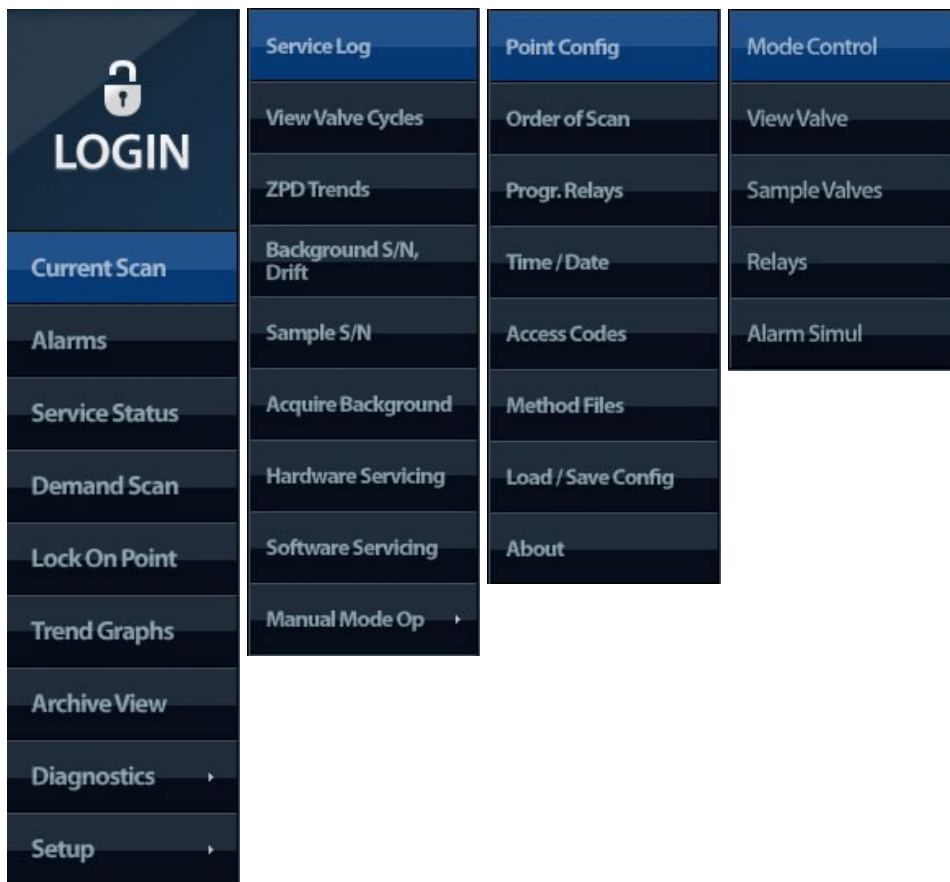

Figure 33. Sidebar menus

To change from the Current Scan display at the ACM 150 monitor, touch the desired menu item. If you access the ACM 150 monitor from a remote computer, use the mouse.

Sidebar Menu 1 Basic

This menu is for All Users. It is always displayed and accessible, providing information about current and historical incidents, trends and status. The menu allows you to select a point for immediate scanning.

Sidebar Menu 2 Diagnostics

This menu is intended for Authorized and Trained Users. It accesses a variety of service functions and tests. Refer to [\](#).

Sidebar Menu 3 Setup

All Users can access this menu to view the Setup program, however, only Authorized Users are able to change the Setup. Refer to [Setup Menus](#).

Alarm 1/Alarm 2 incidents and actions

The primary purpose of the ACM 150 monitor is to generate a Alarm 1/Alarm 2 Incident whenever the level of a hazardous gas exceeds set point limits. Such incidents cause a number of actions to occur automatically:

- The Alarm 1 or Alarm 2 condition changes on the [status bar](#) and on the [Recent scan results](#).
- The data is logged as a recent Alarm 1/Alarm 2 incident ([Alarm 1/Alarm 2 incident log](#)).
- One or more relays activate, which is determined by the setup program for the relays ([Relay activation](#)).
- The incident is archived along with the infrared spectrum
- The data is available for graphical trending
- These incidents, along with the normal scan data, are available for interfacing to a PLC or network computer Ethernet or Lonworks.
- Network or remote computers connected via Internet protocol may be set to print each incident as it occurs.

Alarm 1/Alarm 2 incident log

Press Alarm 1/Alarm 2 to access the incident log. Shown below is an example of the data provided. The incidents are listed in chronological order. Incidents are identified by sample area and gas type. The log shows the status (Alarm 1 or Alarm 2) of the leak, the time and date it was initially detected (started) and the time and date it cleared. The ACM 150 alarm status reset behavior is conditional; it depends upon the acm.cnf setting of the "EnablePreWarn = No" variable, which has a default setting of "No." When "EnablePreWarn = No," if a gas concentration drops to normal below AL1 (Warn) setting, the current status is set to "O" = Normal = no AL1 and no AL2. This reading does not have to be 0.000, just no greater than the AL1 setting. When "EnablePreWarn = Yes," if a gas concentration drops to normal below AL1 (Warn) setting but still shows a small fractional positive reading > 0.0 and the previous status was AL1 or AL2 (Warn or Alarm), the current status is left as AL1 or AL2 as before. So if EnablePreWarn is set to Yes, the ACM 150 alarm system will be returned to "alarm status = normal" if and only if the gas reading is absolutely = 0.000.

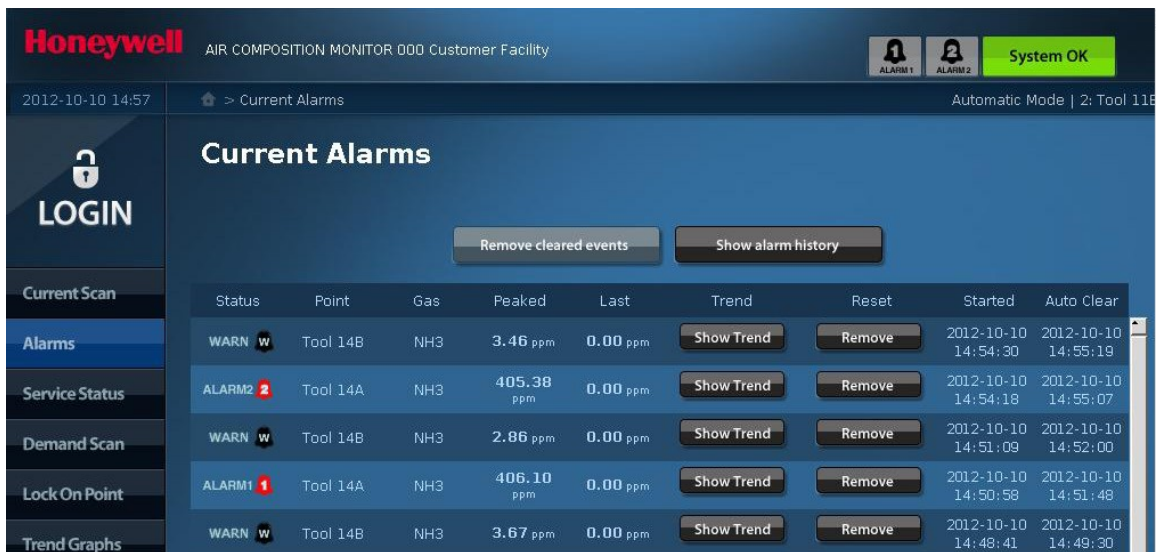

Figure 34. Current alarms

Press “Show Alarm History” to display the last 500 Alarm 1 or the last 500 Alarm 2 events of the past.



Figure 35. Alarm history.

When the alarm history is displayed, press “Backup this list...” to generate the “al_back.csv” file. After the file has been created locally, you may export it to a USB memory stick (or to your Desktop PC if you are operating remotely).



Figure 36. Alarm event backup

Every time “Backup list” is pressed, the complete history is appended to the end of the existing file. Older data is not overwritten and cannot be lost.

The Alarm 1/Alarm 2 Incident Log shows two gas concentration values:

Peaked	the maximum or peak reading
Last	the most recent reading

Press “Show Trend Key” to display the trend for the current 2-hour period only. If the leak event cleared earlier than the current 2-hour period, you can review the archived trend graph ([Trend graphs](#)).

The Reset Key is used to release activated relays. If you are using the optional latching relays, use this selection to reset and deactivate the relays. Press “Remove cleared Alarms” to clear all alarms from the past history.

Relay activation

When a Alarm 1/Alarm 2 Incident occurs, the ACM 150 monitor software activates the corresponding relays. All ACM 150 monitors have at least 80 output relays. The action of each relay is programmable. The default setup for the ACM 150 monitor assigns these relays to area 1-40. One Alarm 1 level and one Alarm 2 level relay is assigned to each area. The user can easily change the assignments, programming the relays for customized activation via the setup menu, [Programmable relays](#).

Default relay setup

- Relays 1-40 activate when the Alarm 1 level is exceeded for any active gas at areas 1-40 with one Alarm 1 level relay per area.
- Relays 41-80 activate when the Alarm 2 level is exceeded for any active gas at areas 1-40 with one Alarm 2 level relay per area.
- Example: For area 1, relay 1 and relay 41 are preassigned for Alarm 1 and for Alarm 2 level activation. This progression continues through to area 40.

Programming relays

The ACM 150 monitor output relays are all programmable. The relays may be configured by an authorized user to activate based on the following selections:

Trigger	The Alarm 1 or Alarm 2 level gas concentration
Mode	Direct or Latching
Activation Points (Areas)	For one point only or any group of points up to a maximum of 10 points
Gases	Select which monitored gases activate the relay

Each programmable relay is customized to activate for specific areas and under specific conditions. For example, it gives the user control over which conditions might shut down specific gas cylinders. It allows the user to set zones for personnel alarms so that entire facilities do not have to be evacuated if a leak is local or if the gas leaking is not hazardous at the level detected.

Typically, alarm incidents are brief and quickly clear if automatic gas shutdown is activated by the alarm event. With the gas supply cut off, the leak should dissipate. However, if the leak is not shut off, the ACM 150 monitor will most likely sense the alarm event each time it scans the leaking area(s).

NOTE

The Alarm 1 and Alarm 2 set point levels and the programmable relay groups are to be determined and set by EHS professionals. They must not be reset to different levels and the program groups must not be changed in any way unless determined and authorized by those professionals.

Standard Non-Latching Relays

The standard ACM 150 monitor configuration has the relays remain closed as long as the concentration of a gas exceeds a set point. Once the gas concentration reaches 0 ppm, the relay resets and opens. This is preferred by most users because they connect these relays to PLCs or external controls that latch, i.e. remain closed until manually reset.

Special Latching Relays

If you do not have latching relays in your control scheme, then Honeywell Analytics recommends that the ACM 150 monitor relays be changed to latch. This is a simple configuration change in the ACM 150 monitor software. When set to latch, the relays must be manually reset to open. This is done by selecting “Reset” in the alarms log.

DANGER!

Resetting a latching relay could cause a leak to restart and expose employees to hazardous conditions. Make certain that the leak causing the initial alarm event has been corrected before resetting a latching relay.

DANGER!

La réinitialisation d'un relais de verrouillage pourrait provoquer une fuite de redémarrer et d'exposer les employés à des conditions dangereuses . Assurez-vous que la fuite provoquant l' alarme initiale événement a été corrigée avant la réinitialisation d'un relais de verrouillage .

Action plan

Since the monitor can detect multiple gases per port, the action plan can be tailored for each gas. Every user should have a plan of action for Alarm 1/Alarm 2 incidents. Refer to “Form 2: Plan for ACM 150 incidents” on page 76 for a suggested plan and format.

Lock-on mode and demand scan mode

Lock-on mode

The Lock-on Mode interrupt the normal scanning to lock onto an area and monitor it continuously for some period of time. It is often used following the detection of a Alarm 1 or Alarm 2 level leak. It allows you to monitor the area where the leak occurred, observing the gas concentrations as they change to determine if the level is increasing or decreasing. It is a recommended procedure when ERT employees go to the sample point to check for the source of the leak. You can communicate with the ERT employees and report the readings to them if they start to change. The Lock-on Mode can help ERT determine when it is safe for workers to re-enter an area.

The Lock-on Mode is also used to introduce a test chemical while the ACM 150 monitor is locked onto the area. Lock-on Mode data is archived.



Figure 37. Lock-on mode menu

The Lock-on Mode screen, [Figure 37](#), allows you to select the area you want to scan. You can only select an area that has been setup for monitoring, which is indicated by a green box. Areas with greyed-out boxes are not set up and cannot be selected.



Figure 38. Lock-on mode menu buttons

Once selected, this area is scanned at the same rate as normal scanning. The display, [Figure 39](#), identifies the point (area) number selected. Each time a scan is completed, the display updates to show the latest data as well as the number of passes (scans). It continues scanning the locked area repeatedly until you press “Cancel Lock-On” or the 60 minute time-out automatically returns it to the normal scanning mode.

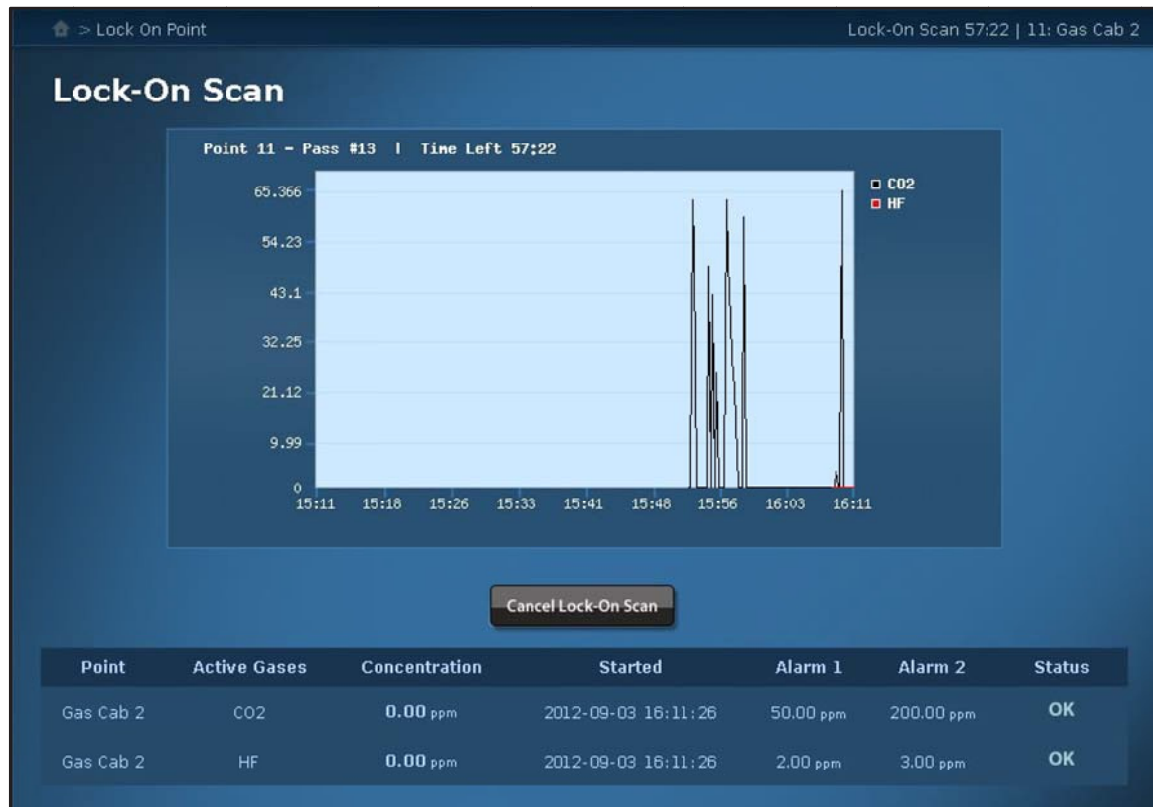

Figure 39. Lock-on mode results

Demand scan mode

The Demand Scan Mode interrupts normal scanning to conduct 2 scans of the selected area. Normal area scanning resumes automatically.

Demand Scan is intended for the following uses:

- To provide a quick means of monitoring any area during an emergency and reporting the levels of hazardous gases present there.
- To help identify the chemical composition of unknown odors in the workplace, whether or not they are a monitored component.
- To store the infrared spectrum of the air sample from the selected area for off-line identification work at a later time, e.g. using spectral search software.

The Demand Scan menu, [Figure 40](#), is identical to Lock-on Mode, and selections are made in the same manner. Only areas with green boxes can be selected. Areas with greyed-out boxes cannot be selected.



Figure 40. Demand scan menu

After an area is selected, normal scanning is interrupted while two scans are collected. The results are displayed as shown in [Figure 41](#). The concentration readings and status of each active gas at the sample point are displayed. Programmable relays activate if Alarm 1/Alarm 2 set points are exceeded. Normal area scanning resumes in the background as soon as the Demand Scan is completed. Nevertheless, the display remains until another mode is selected on the touchscreen.

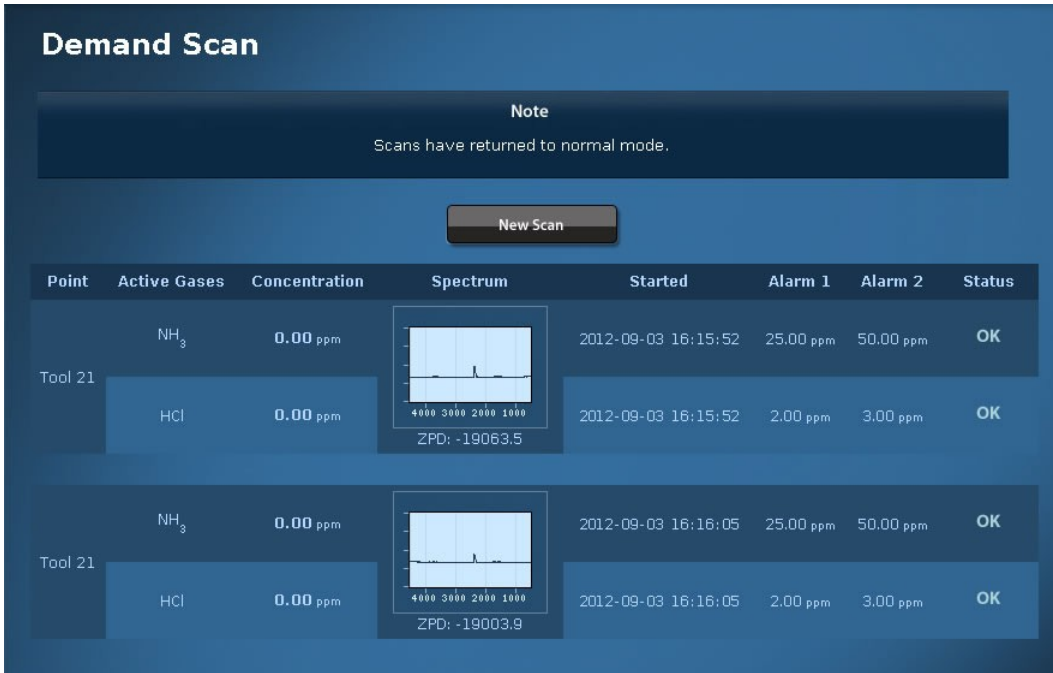

Figure 41. Demand scan results

In Demand Scan the infrared spectrum is displayed, and it may be expanded for viewing by touching the display. At the same time, the data and the spectrum are archived automatically. The archived spectra may allow an application chemist identify gases which were in the sampled area at the time but not actively monitored.

Trends and archives

Trend graphs

Trend Graphs are available for all of the active gases on every scanned point. The data from each scan is stored for this purpose. Trend Graphs provide a means of viewing a leak incident from start to finish.

Trend Graphs are available in the menu shown in [Figure 42](#). You must enter a date, a starting hour and an ending hour. Only one date may be selected. The minimum time interval is one hour and the maximum is 24 hours. Time entries use the 24-hour clock. You can not enter minutes. Use the number keys to make the entries. Then, press one of the scanned areas (green box) for trending.



Figure 42. Trend graph menu

Pressing the selected area changes the display by generating a trend graph. [Figure 43](#) shows a graph of four gases over a one day time period. In this case, there is a constantly changing CO₂ concentration shown in green color.

To rescale the y-axis for a greater resolution enter a value in the empty field and press “Rescale”.

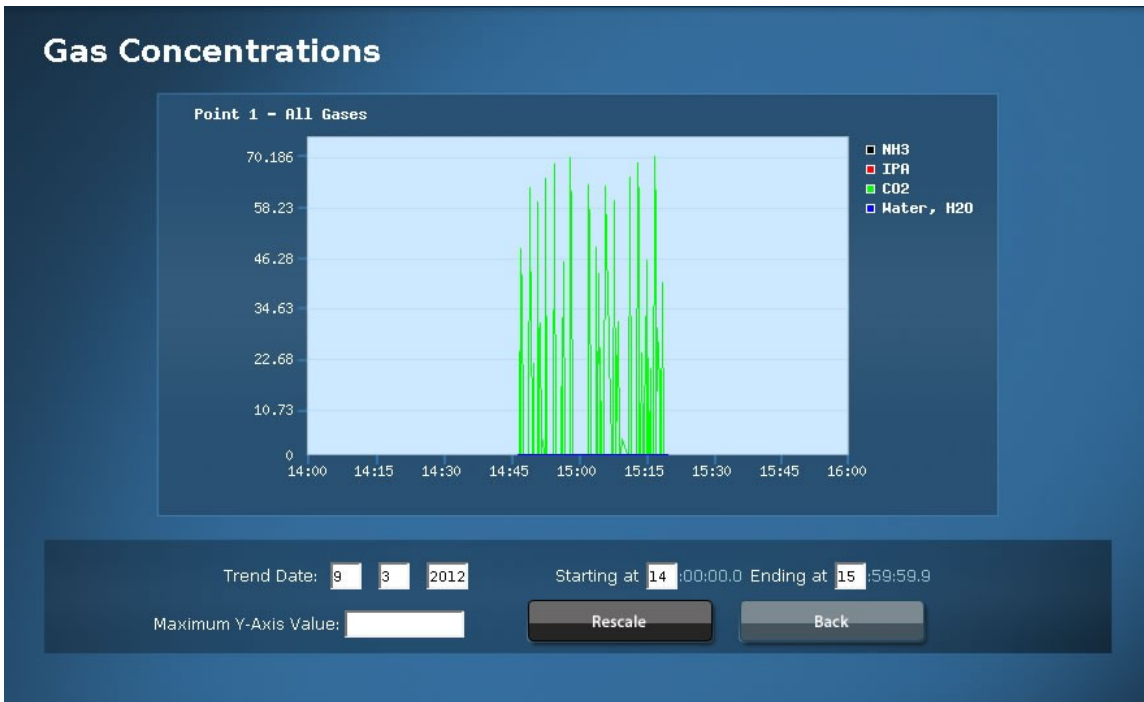

Figure 43. Trend graph display

Archive view

The ACM 150 monitor stores the infrared spectrum data from all its modes for the past 30 days. The Archived View allows you to selectively review and identify these spectra.

When you select Archive View, the menu shown in [Figure 44](#) display. Use the number keys on the keyboard to enter the desired date and the time interval. Next, choose any of the three Scan Types, and then the desired Status Results. The following rules apply to the Scan Types:

Normal: Scans collected in the normal scan mode. Generally, only the Alarm 1 and Alarm 2 normal scans are important to the user. Validate some of these Alarm 1/ Alarm 2 incidents by reviewing the spectra (or emailing spectra to Honeywell Analytics for review and comment). If you press “Load Data”, the data field ([Figure 44](#)) red. Narrow the time to a one-hour period to hide spectra when no incidents occurred.



Figure 44. Archived view

Demand and Lock-On: Scans collected in either the Demand or Lock-On modes.

Since these modes are infrequently used, you can select all three Status Results and search 24-hour periods. Narrow the time period if the field in [Figure 45](#) becomes too large. View or save only the spectra of interest.

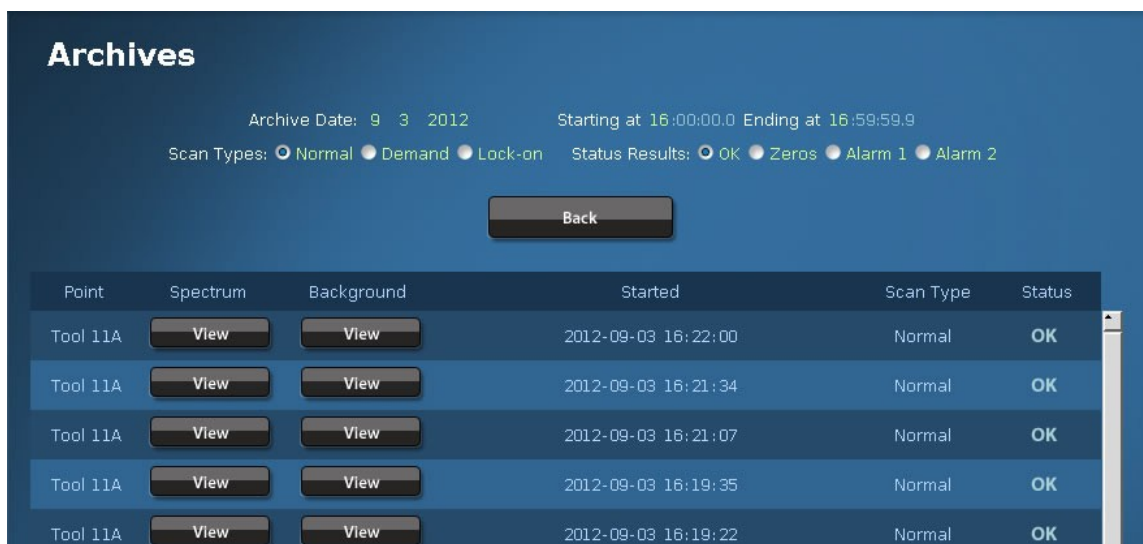

Figure 45. Archived spectra

Time-weighted average

The software features TWA (Time-Weighted Average) and MTD (Month-to-Date) reporting. Every eight hours an average gas concentration for each point and gas is calculated and saved to a TWA file on the ACM 150 monitor hard drive. In addition, an MTD file may be created to calculate an average gas concentration for the last 30 days.

By default, the TWA files are stored in the local folder `/home/HA/twa/` and MTD reporting is deactivated.

ACM 150 checklist and incident plan

ACM 150 monitor is designed for continuous operation 24 hours a day. It performs all of its functions automatically. Operator interface is only needed when an incident is detected by the ACM 150 monitor. In all cases, such incidents are noted on the Status Bar, [Figure 31](#) and they activate one or more of the output relays. Nevertheless, it is important to remember that the system is installed for the purpose of detecting chemicals which may be dangerous to workers and/or harmful to the environment. For this reason, it is imperative that the system not be taken for granted.

Plan for ACM 150 incidents

You can use Form 2 “Plan for ACM 150 incidents” to list and correlate the sample area numbers to the names for those areas and to the order of scan. The form may also be used to record and describe any Alarm 1/Alarm 2 or Malfunction Incidents. The telephone contact list can be part of your action plan to resolve issues.

The ACM 150 monitor’s computer continually checks for malfunctions in the analyzer and the sampling system. Some malfunctions are temporary and self-corrected. For example, if the ACM 150 monitor acquires a “bad scan”. That scan will be rejected

and the system will try again. If it can not complete a good scan, a malfunction will be generated. Some malfunctions, such as a failure of the optional Line Leak Check, do not interrupt the operation of the ACM 150 monitor. It will continue to scan normally after this malfunction is detected. Other malfunctions, such as a “bench time-out” will cause scanning to be interrupted.

Screening data

Warn / Alarm 1/Alarm 2, questionable results and shakedown

During the first few weeks of operation, expect some “shakedown” of the ACM 150 monitor to be necessary. You may get some low level readings for certain chemicals, especially if they are measured in the water vapor region of the infrared spectrum. It may be necessary for the Honeywell Analytics application chemist to adjust the analytical method for the specific background purge gas and normal air chemistry at the user’s location.

During this initial operating period, collect infrared spectra and send it to Honeywell Analytics. The application chemist will use this information to make adjustments to the analytical methods. If necessary, new methods will be generated and sent to the user or installed by HA or its agent. The user should also collect and the spectra generated during any of the following events:

Demand Scans	Used when a chemical level is suspected or unknown odor (‘chemical stranger’) is present
Warn / Alarm 1/Alarm 2 Incidents	Includes both known and suspected events as well as questionable events, where a false alarm may be suspected
Gas Tests	Where a known chemical was introduced by the user and the ACM 150 monitor fails to report it or does not agree with the concentration level

Malfunction messages generated during this initial period may occur due to the characteristics of the particular installation. Notify Honeywell Analytics Service Department or its agent of all malfunctions, even if they are corrected by the user or are self-corrected, during the first few months of operation. Thereafter, the user can limit such notification to times when service assistance is needed to resolve a problem.

Record all of the incidents on Form 3, "Details of alarms, problems or non-spec performance."

Form 2: Plan for ACM 150 incidents

Port #	Active Points	Sample Point Name or Equipment ID #	Actions for Warn/ Alarm 1/Alarm 2 Incidents
1			
2			
3			
4			
5			
6			
7			
8			
9			
10			
11			
12			
13			
14			
15			
16			
17			
18			
19			
20			
21			
22			
23			
24			
25			
26			
27			
28			
29			
30			
31			
32			
33			
34			
35			
36			
37			
38			
39			
40			

Form 3: Details of alarms, problems or non-spec performance

Noted by: Date/Time:

Note

Store spectra of all Alarm 1/Alarm 2 Incident(s).

For an expert evaluation, contact your local representative.

You can e-mail files directly to Honeywell Analytics.

Signal-to-noise ratio

Important warning and disclaimer:

Enabling signal-to-noise ratio (SNR) on samples could lead to a situation in which legitimate gas detection is inhibited. Any gas in the sample cell absorbs in a given infrared (IR) region. A Fourier Transform Infrared (FTIR) uses this infrared absorption to detect gases. However, if the infrared absorption is in an SNR region, it decreases the infrared signal and therefore decreases the SNR. If infrared absorption is decreased below the SNR cutoff, the ACM software can classify the spectrum as "low SNR" and reject it before the spectrum is analyzed for gas concentrations. This is a potential false negative reading of gas1, caused by an innocuous interfering gas2.

For example, if the following noise areas are chosen for SNR calculation with an SNR setpoint of 100:

- Sample/Background RMS* Noise Area 1 = 968-1008, 100
- Sample/Background RMS Noise Area 2 = 2480-2530, 100
- Sample/Background RMS Noise Area 3 = 4380-4430, 100

*RMS = root mean square

The ACM 150 monitor software will check the RMS SNR over these regions and, if configured to do so, will ignore readings of any gas if the SNR reading in any of the three regions is <100. However, a release of a 250 PPM concentration of C₅F₈ (CAS 559-40-0, ACGIH TWA 2.5 PPM) will absorb in RMS Noise Area 1, decreasing the SNR from over 500 to less than 10. Since 10 < SNR setpoint of 100, the ACM 150 monitor will ignore the 250 PPM reading of C₅F₈ and gas concentration readings of the other fourteen gases scanned at that point.



Enabling SNR in the background does not inhibit gas detection. When the background signal-to-noise ratio is calculated on "background gas," there are no interfering gases since backgrounds are done with dry nitrogen.

DANGER!

Enabling the signal-to-noise ratio on samples can inhibit gas detection. Honeywell Analytics does not recommend this setting. The customer enables the signal-to-noise ratio on samples at their own risk. Honeywell Analytics disclaims all liability resulting from customers enabling signal-to-noise ratio on samples.

DANGER!

Activation du rapport signal -sur-bruit sur des échantillons peut inhiber la détection de gaz . Honeywell Analytics ne recommande pas ce paramètre . Le client permet le rapport signal -sur-bruit sur des échantillons à leurs propres risques . Honeywell Analytics décline toute responsabilité découlant de clients permettant rapport signal sur bruit sur les échantillons .

ICON KEY	
	Authorized Users
	Trained Technician

Setup Menus

Accessing the setup

View setup

Any user can view the setup program menus for the ACM 150 monitor. The setup menu screens show how the ACM 150 monitor is currently configured.

Change setup

Only authorized users with an access code are permitted to change the setup program. You must login before changes can be made. After making changes, logout to prevent unauthorized changes to the setup.

Point configuration

All users can access this menu. The Point Configuration, [Figure 46](#), shows all of the ACM 150 monitor sample points (areas) and their current status.

The chart below explains the status indicators and what they mean. Only the points having a filled blue circle may be scanned by the ACM 150 monitor. However, the filled circle does not indicate that the point is currently scanned. Points can only be scanned if they are listed in the [Order of scan](#).

Points with a blank circle have been configured, but they are on hold until they are enabled. Such points can not be scanned. Use this to prevent scanning points that are not ready, e.g if the tubing or the equipment to be monitored is not yet installed.

If you know the name for a point but not the gases to be monitored, you can assign the name now and configure the gases later. If there is no status indicator next to the point, it has not yet been configured.

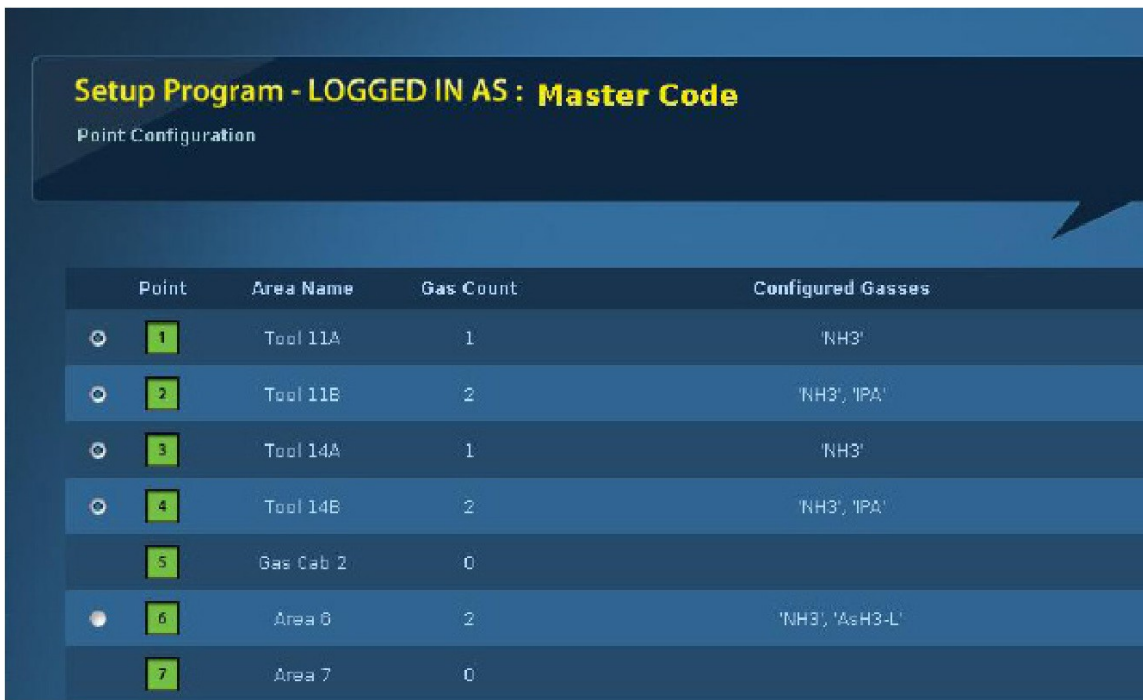

Figure 46. Point configuration

	<p>Active Indicates the point is configured and active. The scan has been enabled. It may be enabled in the Order of Scan.</p>
	<p>Inactive Indicates the point is configured but not active. Scan must be enabled before the point can be included in the scan cycle.</p>
	<p>Named/Non-Configured A name, 'Gas Cab 2', is assigned to the point, but it has not been configured.</p>
	<p>Non-Named / Non-Configured Indicates a name has not been assigned to the point, and it has not been configured.</p>

Setup Program - LOGGED IN AS : Master Code
 Point Configuration
 Single Point Configuration

Point: 22
 Name: Rename

Back Remove All Select Gases

Active Gas	Alarm 1	Alarm 2	Modbus		
Method: ACMtest 07-22-04					
NH3	10000 ppm	10000 ppm	1	Set Parameters	Remove
IPA	10000 ppm	10000 ppm	2	Set Parameters	Remove
CO2	10000 ppm	10000 ppm	3	Set Parameters	Remove
Water, H2O	10000 ppht	10000 ppht	4	Set Parameters	Remove

Figure 47. Point status

Reviewing and changing point configurations

Until you login with an access code, you can only review but not change point configurations. After you login, the display changes to open up your configuration options.

Setup of unconfigured sample points

When you select an unconfigured point, all of the available methods are displayed. If the ACM 150 monitor monitors only a short list of gases, you may have only one method. If you have a large number of gases, you will have multiple methods installed.

NOTE

A method is a group of gases. A Honeywell Analytics application chemist reviews the list of gases you want the ACM 150 monitor to monitor at each sample point, arranges them into logical groups and develops the groups into methods (described in section [Analytical methods](#)). When configuring a sample point, you may choose gases from one or multiple methods.

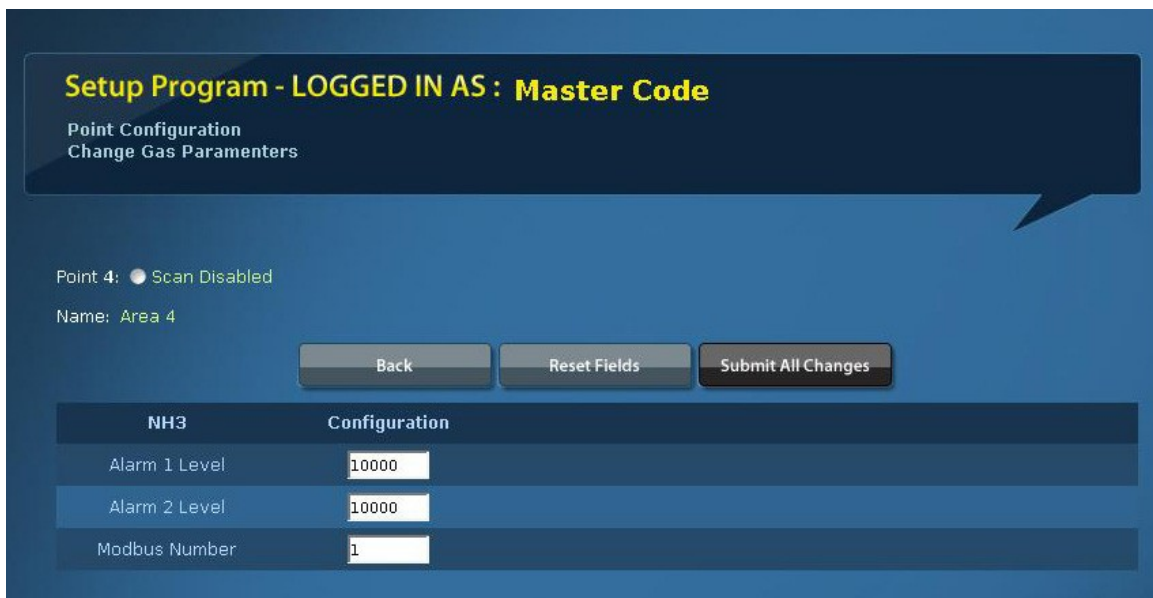
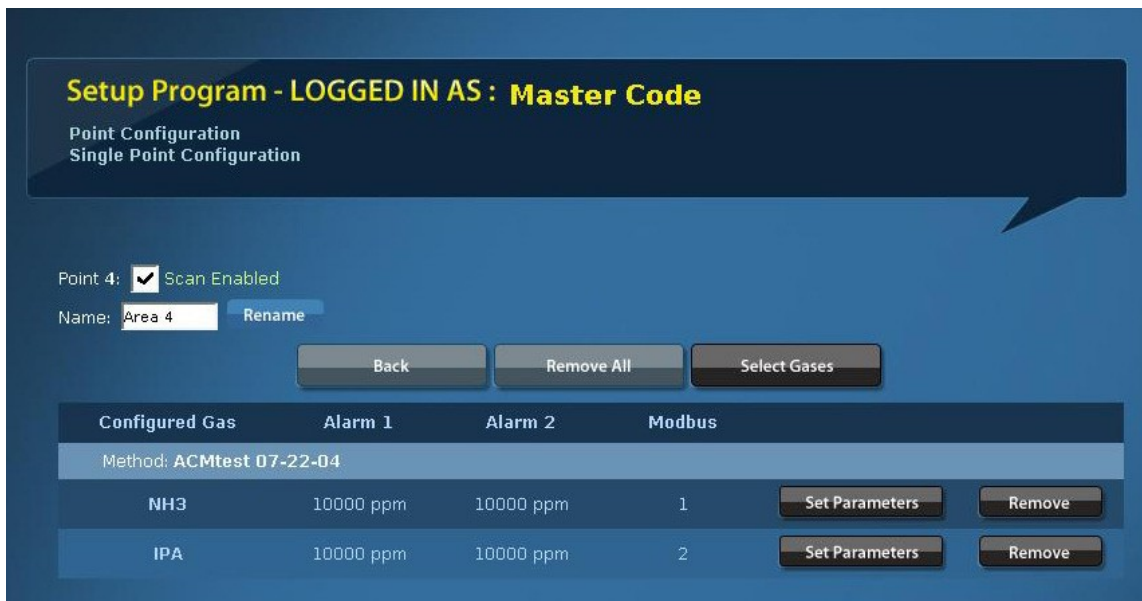

Figure 48. Editing the configuration

Configure each point using the steps listed in the table below: Table 2. Point configuration steps

1	Enter a name for the sample point that identifies the specific equipment or location in your facility. Form 1 may be used as your master list of sample point names.
2	<p>Scroll down the list of methods and select one that includes all of the gases you want to monitor at that point.</p> <p>NOTE If one method does not contain all of the gases for that point, choose gases from multiple methods.</p>

3	<p>After selecting the method, choose which of the gases you want to monitor. A check mark indicates the gas is selected.</p> <p>NOTE If you limit the list to only those gases which might be present at the sample point, it improves the quality of the analysis. Gases that are not selected are not monitored on that point by the ACM 150 monitor.</p>
4	<p>Enter a value for the Alarm 1 and the Alarm 2 set points. Alarm 1 is the lower value and can not be set higher than the Alarm 2 value. The set points should be decided by EHS personnel or by established procedures.</p> <p>NOTE For points in occupied areas, most users set the Alarm 2 equal to the TLV-TWA (if known) and the Alarm 1 to 50% of the TLV-TWA.</p>
5	<p>If using the Modbus/TCP interface, enter a unique number in the range between 1 and 16 for each gas.</p>
6	<p>If the sample tube is installed and you are ready to monitor the point, select SCAN ENABLED. A check mark indicates it is enabled.</p>
7	<p>After you complete your selections, press "SUBMIT CHANGES" to make them active.</p>

Order of scan

The Order of Scan defines the sequence of point scanning. Points may be scanned in any order, and points may be repeated in the sequence. It is also possible to have points in the sequence without making them active.

Reviewing the order of scan

Enabled points are distinguished by a filled blue circle. These points will be scanned. Points with a blank circle will not be scanned. Scroll down the page to view the complete sequence.

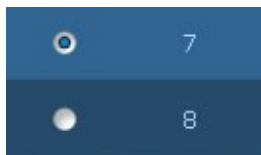

Figure 49. Enabling points to be scanned

Configuration key

For reference, a configuration key displays down the right side of the screen. This key indicates which of the points are enabled in Point Configuration.

NOTE

Only points with Scan Enabled in the Single Point Configuration can be scanned. The Configuration Key identifies the enabled points. Use this key as a reference for the Order of Scan, enabling only those points which are active.

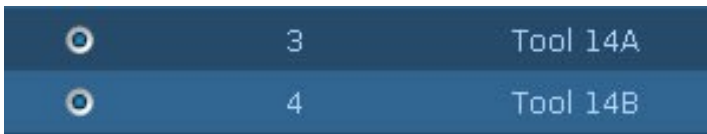

Figure 50. Configuration key

Reviewing and changing the order of scan

Until you login with an access code, you can only review but not change the order of scan. After you login, you may edit the sequence and enable or disable points.

When editing Order of Scan follow the steps in [Table 3](#).

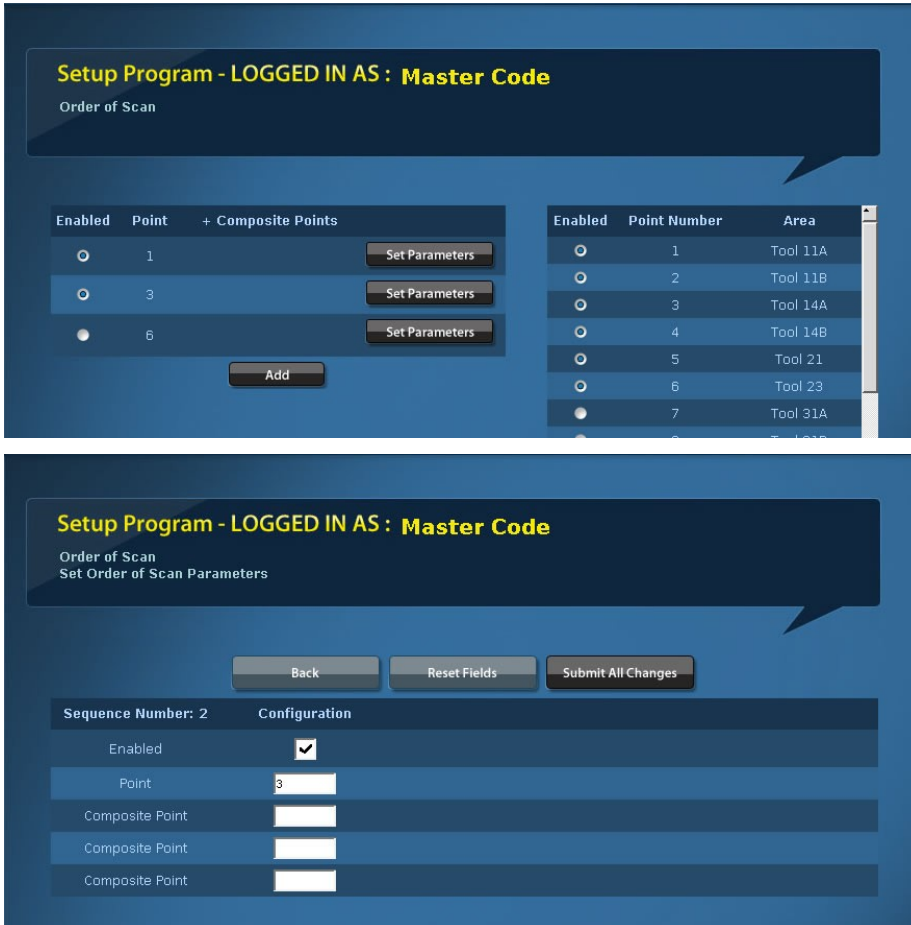

Figure 51. Editing the order of scan

Table 3. Order of scan editing steps

1	<p>Decide on the scan sequence you want to use before you make any changes.</p> <p>Note that points may be scanned in any sequence. If you want the ACM 150 monitor to spend more time scanning one or more critical points, you can repeat the point(s) in the sequence. Order of Scan allows a maximum sequence of 87 entries.</p>
----------	---

2	<p>Refer to Configuration key. This shows you which points are enabled for scanning. If you want to scan a point that is not enabled, go to the Single Point Configuration to enable it.</p> <p>Note that if you are not ready to enable a point, you can put it in the sequence now and enable it later. To enable it later, first enable it in the Single Point Configuration. Then, enable it in the Order of Scan.</p>
3	<p>If you change the order of scan, you will have to re-enter the scan points starting with the change you made until the new sequence is complete. Scroll down the list, as needed, to complete all of your entries.</p> <p>Note that if you want to scan points in their numerical order, enter a sequence, e.g. 1-40.</p>
4	<p>Select the points you want to enable at this time. Enabled points have a blue dot.</p>
5	<p>If you must take a point out of the scan sequence temporarily, remove the blue dot to disable it. When it is ready to scan again, enable it.</p> <p>Note that when tools are taken out of service, e.g. to be moved or replaced, or when construction work is on-going at a point, you can put scanning of these points on temporary hold.</p>
6	<p>Press RESET FIELDS, if you make a mistake and want to recover the prior sequence.</p>
7	<p>After you complete your selections, press "SUBMIT CHANGES" to make them active.</p>

Composite points

Up to 4 points may be sampled together by the FTIR to speed up the scan rate. The disadvantage of composite sampling is that the lower detection limit is raised because the sample from one point is diluted by the flow from the other sample points in the group.

When the ACM 150 monitor detects any non-zero gas concentration, it finds which point has the target gas by searching, one-by-one, through all the points in the group. Because any gas concentration other than zero will trigger a search, water detection should not be active on any composite points.

When the points are scanned individually, they are treated as any point in normal scanning. The dilution factor does not apply. Alarm 1 / Alarm 2 incidents initiate the actions as described in [Alarm 1/Alarm 2 incidents and Actions](#).

Composite Point groups have only one advantage. They shorten the scan cycle. Since the ACM 150 monitor typically monitors air having no target gases present, the readings are zero most of the time. Composite sampling enables the ACM 150 monitor to increase its rate of scan until a gas leak occurs.

CAUTION!

Composite point sampling may expose employees to hazardous conditions by lowering the gas detection capability. Use Composite Points only if the rate of scan must be increased. The following rules apply and must be followed:

1. Group only the sample areas that are in close proximity to avoid combining long and short tube runs, which may cause an imbalance in the composite mixture.
2. Group points which have identical Single Point Configurations, i.e. the same method with the same active gases and the same Alarm 1 and Alarm 2 set points.

MISE EN GARDE!

Point Composite échantillonnage peut exposer les employés à des conditions dangereuses par l'abaissement de la capacité de détection de gaz . Utilisez Points composites que si le taux de balayage doit être augmentée. Les règles suivantes sont applicables et doivent être suivies :

1. Groupe seules les zones de l'échantillon qui sont à proximité d'éviter de combiner longues et de tubes courts tirages , ce qui peut causer un déséquilibre dans le composite mélange.
2. Points Groupe qui ont identiques Configurations point unique, à savoir le même méthode avec les mêmes gaz actives et la même Alarmes 1 et 2 ensemble des points

Programmable relays

The ACM 150 monitor has 80 programmable relay outputs. The functions and uses of the relays are described in section [Alarm 1/Alarm 2 incidents and actions](#). These relays have a default setup that controls their program until that setup is changed.

Reviewing the programmable relays

Relay 1 is preassigned to point 1. It activates when the Alarm 1 level set point is exceeded for 'all gases'. Relay 2 is preassigned to point 2 at the warn level. This progression continues through relay 40 and point 40.

Relays 41-80 follow the same progression, i.e. relays 41-80 are preassigned to points 1-40. Relays 41-80 activate at the Alarm 2 level set point for all gases.

"All gases" applies to the gases actively monitored at that point. If one or more of these gases exceeds its Alarm 1 set point, relay 1 would activate. If any of these gases exceeds its Alarm 2 set point, relay 41 would activate.

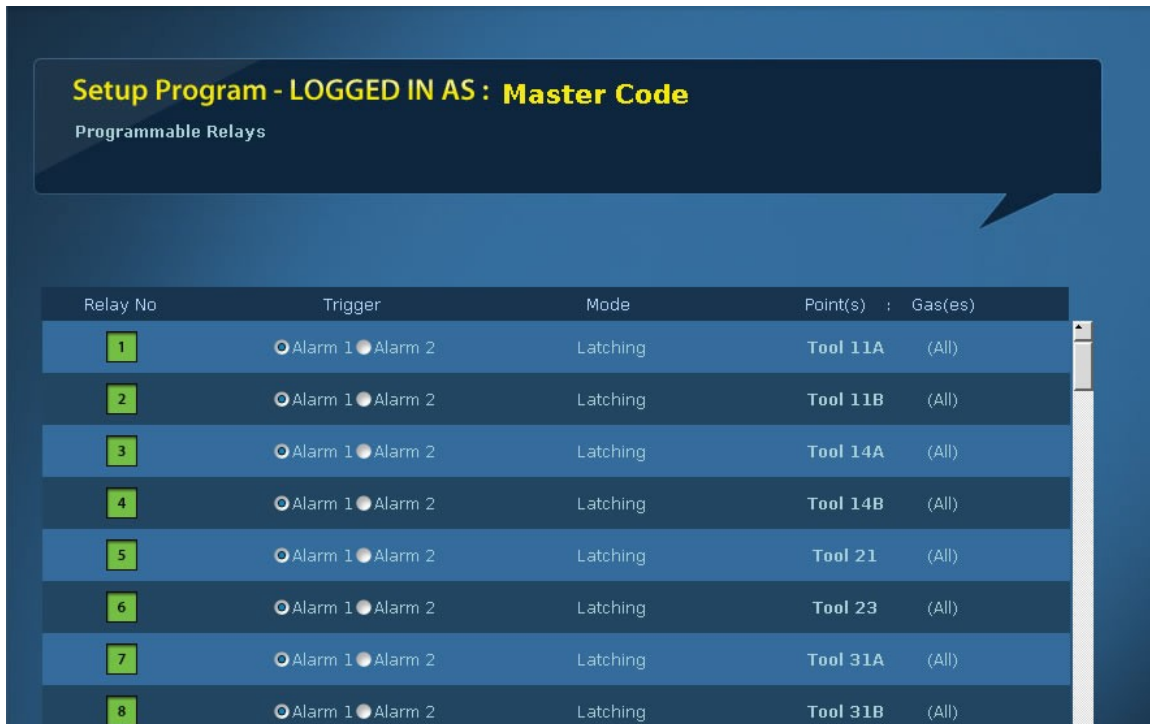

Setup Program - LOGGED IN AS : Master Code
Programmable Relays

Relay No	Trigger	Mode	Point(s)	Gas(es)
1	<input type="radio"/> Alarm 1 <input checked="" type="radio"/> Alarm 2	Latching	Tool 11A	(All)
2	<input type="radio"/> Alarm 1 <input checked="" type="radio"/> Alarm 2	Latching	Tool 11B	(All)
3	<input type="radio"/> Alarm 1 <input checked="" type="radio"/> Alarm 2	Latching	Tool 14A	(All)
4	<input type="radio"/> Alarm 1 <input checked="" type="radio"/> Alarm 2	Latching	Tool 14B	(All)
5	<input type="radio"/> Alarm 1 <input checked="" type="radio"/> Alarm 2	Latching	Tool 21	(All)
6	<input type="radio"/> Alarm 1 <input checked="" type="radio"/> Alarm 2	Latching	Tool 23	(All)
7	<input type="radio"/> Alarm 1 <input checked="" type="radio"/> Alarm 2	Latching	Tool 31A	(All)
8	<input type="radio"/> Alarm 1 <input checked="" type="radio"/> Alarm 2	Latching	Tool 31B	(All)

Figure 52. Review programmable relays - default

Selecting the relay program

Follow the steps in [Table 4](#) when assigning levels, points and gases to a relay.

Table 4. Relay programming steps

1	Before you proceed to change the default relay program, you should first have a plan for each of the relays you want to program and use. Form 2:, "Plan for ACM 150 incidents" may be used to record your plan.
2	After you login, the relay numbers change to selection buttons. This enables you to select any of the relays. Relays must be individually programmed.
3	Select the relay number, e.g. Relay 3. Once the relay is selected, you must make three selections: <ul style="list-style-type: none"> • first, select the activation level, Alarm 1 and / or Alarm 2 • second, select the mode, either direct or latching • third, select the activation point number(s) for this relay. Note that a relay may be assigned to one point or multiple points, up to a maximum of 10.
4	Press the Next button after entering your selection for point numbers. This takes you to the activation gas(es) screen, shown below. The active gases are listed for each point that you assigned to this relay. Now, select a gas or group of gases you want to assign to this relay. Note that if you want to continue to have 'all gases' assigned, leave all gases selected (make no changes to the default program).
5	Press CANCEL if you need to change any selections from the previous screen.
6	Press RESET FIELDS, if you make a mistake and want to recover the original selections.
7	After you complete your selections, press "SUBMIT ALL CHANGES" to make them active.



Figure 53. Selecting relay gases

NOTE

After programming relays, test them to verify that they are wired correctly to external devices so that they will perform their alarm and control functions properly.

Virtual relay setup.

You can connect the ACM 150 monitor to a PLC or facility computer without hard-wired relays. Virtual relays are available for this purpose. They are accessed using the advanced key, which brings up the SQL Direct Entry display as shown below. This is for advanced programmers only.

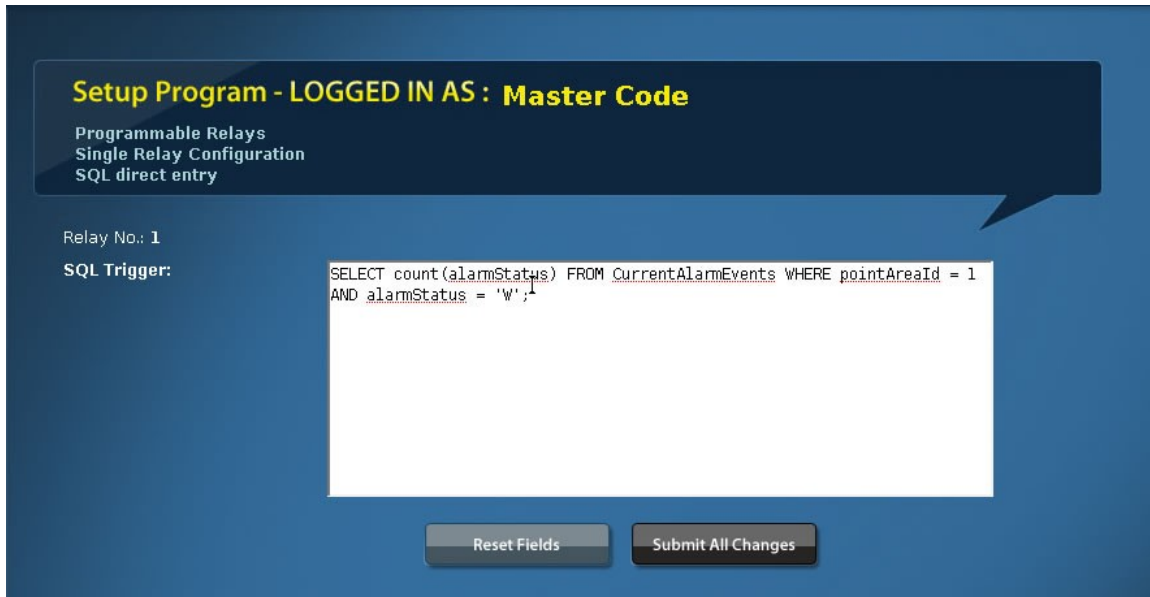

The screenshot displays a web-based interface for setting up a virtual relay. At the top, a dark blue header contains the text "Setup Program - LOGGED IN AS : Master Code" in yellow. Below this, a list of options includes "Programmable Relays", "Single Relay Configuration", and "SQL direct entry". The main area shows "Relay No.: 1" and "SQL Trigger:". A text input field contains the following SQL query:

```
SELECT count(alarmStatus) FROM CurrentAlarmEvents WHERE pointAreaId = 1  
AND alarmStatus = 'W';
```

 At the bottom of the interface, there are two buttons: "Reset Fields" and "Submit All Changes".

Figure 54. Virtual relay setup

Time / date

Set the time, using a 24 hour clock.

The screenshot shows a web-based configuration interface for the ACM 150. At the top, a dark blue header contains the text "Setup Program - LOGGED IN AS : Master Code" in yellow and white, with "Internal System Time / Date" below it. A "Note" box in the center states: "For avoiding inconsistencies, changing the system time or date will reset the ACM automatically." Below the note is a form with six input fields for time and date: YYYY (2012), MM (09), DD (03), HH (16), MM (52), and SS (51). At the bottom of the form are two buttons: "Reload" and "Submit".

Figure 55. Setting time and date

Access codes

Access codes should be assigned only to personnel authorized to make changes to the setup program and to trained technicians who perform services and diagnostics. Select Login, which prompts you to enter a code number.

A Master Code is created by Honeywell Analytics in the configuration software and given to the person in charge of the ACM 150 monitor. That code must be entered when Access Login is selected to pull up the setup menu as shown below. The Master Code may be changed by the user and that code may be used for multiple monitors in the same facility.

When assigning a code set, enter the name of the employee or group assigned to that code set. Passwords require a length of at least 8 digits and must contain at least

- one lower case character
- one numeric character
- one of the following special characters: ! = - * > <

To further grant or deny access to different screens of the user interface, access levels are assigned to various screens and to all users. In order to access a page and change configuration settings, the logged-in user needs an access level equal to or higher than the one assigned to the specific screen. Only the Administrator using the Mastercode may change the Access Level on the screen "Access Codes..."

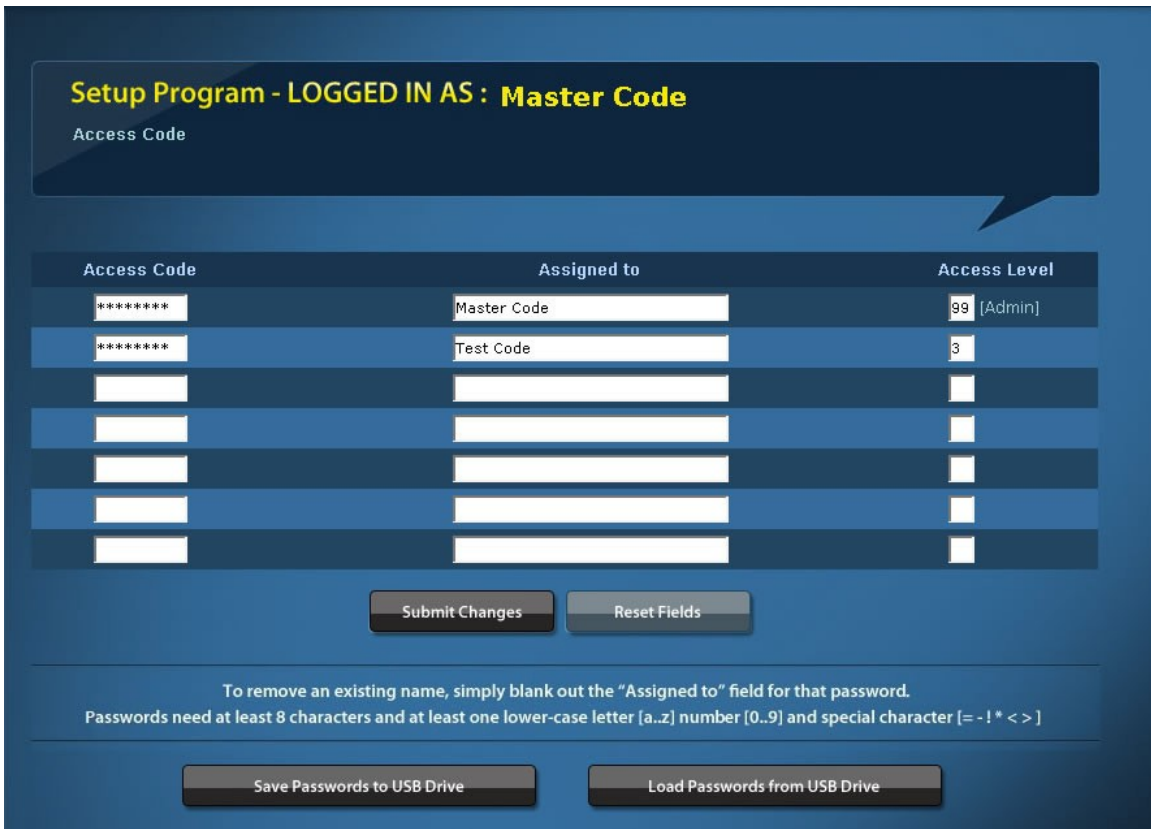

Figure 56. Access codes

Default Access Level	Functional range
Level "0"	View most screens Demand Scan (2 successive scans on one point)
Level "1"	Level "0" + Reset Alarms +Reset Service Events + Lock-On Scan
Level "2"	Level "1" + Change Point Configuration + Change Order of Scan
Level "3"	Everything except Access Codes. Only the Administrator may change Access Codes and Levels.
Level "99"	Administrator using Master Code. (This access level cannot be changed.)

Using a USB memory stick, passwords may now be transferred securely from one ACM 150 to another. To do this, proceed as described below:

- Login directly at the source ACM 150 using the Master Code.
- Go to the Access Codes screen and press “Save Passwords to USB Drive”.
- Remove the USB drive and insert it into the target ACM 150.
- Login directly at the target ACM 150 using the Master Code.
- Go to the Access Codes screen and press “Load Passwords from the USB Drive” and confirm by pressing “OK”.

NOTE

If the Master Code on the target ACM 150 differs from that on the source ACM 150, you will have to manually change the Master Code on the target ACM 150 directly after importing the password there.

The Administrator may choose to increase the number of access levels by assigning higher values for individual screens and users. For enhanced security this feature is described in an external document.

Restricting access to the ACM 150 monitor increases security and control over the monitoring system. Also, it limits the opportunity for errors. Only one or two employees should know the Master Code.

Managing files

Method files

Analytical methods (defined in [Analytical methods](#)) are dynamic. Methods may be updated, new methods added and old methods deleted, as often as required, to keep pace with the ever-changing R&D and production chemicals.

Use the Method Files key to import new and updated methods and to delete methods no longer used. The menu is shown in [Figure 57](#).



Figure 57. Method files

Save / load configuration

After you setup the ACM 150 monitor and each time you change the setup, you want to save the configuration to the ACM 150 monitor hard disk. Also, you should backup the configuration to a USB flash drive. Then, if the software should get corrupted or the hard disk fail, you can save hours of work by loading the configuration from your storage drive.

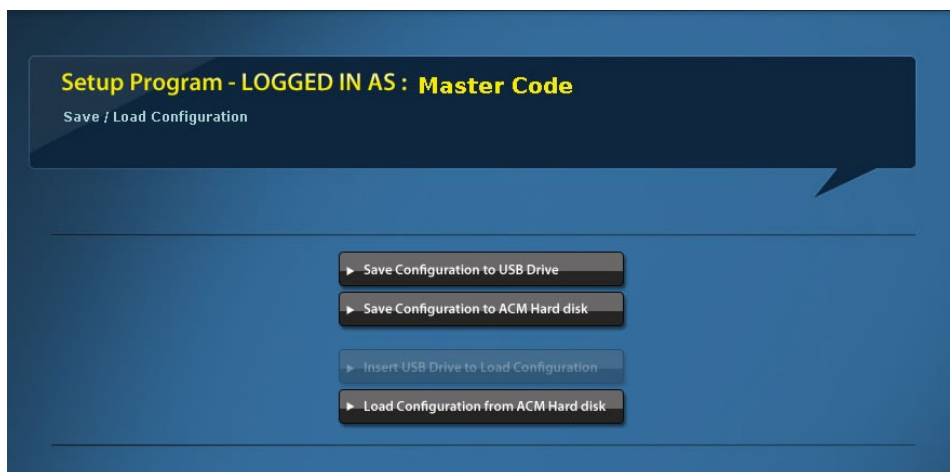

Figure 58. Save/load configuration

Alarm Simulation

For testing communication links to external devices via Modbus/TCP output, such as a PLC connection, the ACM 150 monitor Software v2.10 and higher features Alarm Simulation. For security reasons this screen is password protected and may only be activated with the ACM 150 monitor in Manual Mode.

When simulating an alarm on a specific port and for one or more gases, a message assuing a concentration of Alarm Level + 5% for each selected gas is sent via Modbus/TCP.

For each selected gas the simulated alarm event is displayed on the Alarms screen of the ACM 150 user interface. Simulated alarms show up as auto-cleared alarms and do not trigger the red Alarm icon on the title bar.

In the screenshot below, the top four alarms are simulated while the lower two alarms are for real. Clicking any Remove from List button for simulated alarms will delete all simulated alarms at once.

Status	Point	Gas	Peaked	Last	Trend	Reset	Started	Auto Clear
ALARM2 2 [simulated]	Tool 11B	GeH4	6553.50 ppm	0.00 ppm	Show Trend	Remove	2012-10-02 10:11:23	2012-10-02 10:11:23
ALARM2 2 [simulated]	Tool 11B	AsH3	6553.50 ppm	0.00 ppm	Show Trend	Remove	2012-10-02 10:11:23	2012-10-02 10:11:23
ALARM2 2 [simulated]	Tool 11B	NH3	6553.50 ppm	0.00 ppm	Show Trend	Remove	2012-10-02 10:11:23	2012-10-02 10:11:23
ALARM2 2 [simulated]	Tool 11B	IPA	6553.50 ppm	0.00 ppm	Show Trend	Remove	2012-10-02 10:11:23	2012-10-02 10:11:23
ALARM1 1	Tool 14B	CO2	337.59 ppm	337.59 ppm	Show Trend	Reset	2012-10-02 10:10:20	
ALARM2 2	Tool 11A	Water, H2O	2066.47 ppht	2038.77 ppht	Show Trend	Reset	2012-10-02 10:05:33	

Figure 59. Warn and alarm screen

To simulate alarms perform the following steps:

- Go to Diagnostics.
- Login with a password that has permission for this screen. The default as shipped is Administrator (or a user with Access Level = 3 or greater).
- Go to Manual Mode Op and click the Switch to Manual Mode button.
- When the title bar reads Manual Mode go to Alarm Simul. to see the screen illustrated on the next page:



Figure 60. Alarm simulation

- Select the point you want to simulate alarms on and hit Next.
- Select the gases for simulating alarms and hit Next.
- On the next screen click either Go to activate the alarms or Cancel to abort.

A summary listing all simulated alarms is displayed, see [Figure 61](#):

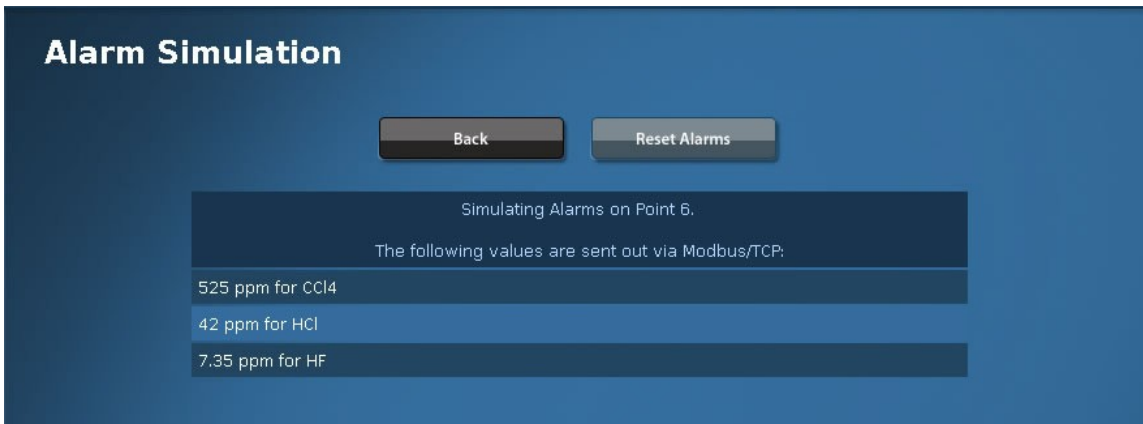

Figure 61. Simulated alarms summary

- Click Reset Alarms to reset the gas concentrations sent via Modbus/TCP to “0.0” or click Back to choose another point to simulate alarms on. You may reset all simulated alarms from the Alarm Sim. main screen anytime later on.

NOTE

Simulated alarms will not be logged and will not trigger the relays of the ACM 150 monitor. For triggering the relays manually, go to the Relay screen in Manual Mode. As soon as the ACM 150 monitor starts scanning again in Automatic Mode, all simulated alarms will be cleared.

Shutdown Procedure

Emergency shut down

Immediately turn off the Main Power Switch located on top of the ACM 150 monitor to disconnect power to all of the internal circuits.



Figure 62. Main power switch

Planned shut down

Line power

- Be aware of any impact that shutting down the ACM 150 monitor may have on your facility and prepare for it, e.g. ‘fail-safe’ relays that activate alarms on loss of power or shut off gases automatically when this system is not on-line. Use appropriate precautions, to avoid unscheduled interruptions of production.
- Turn off the Main Power Switch, [Figure 62](#), located on top of the ACM 150 monitor.
- Follow [Lockout / Tagout Procedure](#) when shutting down the monitor for service or relocation.

Utility gases

The ACM 150 monitor uses compressed air (global) and nitrogen. The user is required to provide an external shut-off valve located nearby (refer to [Utility gases and exhaust piping](#)). These valves can remain open during shut down, provided these utility gases and the components they supply remain connected.

Under these conditions you should close the external shut off valves:

- The system is shut down for an extended period, taken out of service or relocated.
- The venturi pumps or gas cell are serviced.
- The utility external connections ([Figure 25](#)) or the internal supply lines are disconnected.

CAUTION!

This is a high pressure safety hazard. The compressed air (CDA) supply pressure normally exceeds 100 psig (7 kg/cm²). After shutting off the external supply valve, check the internal pressure regulators on the CDA Panel, [Figure 20](#), to ensure that they read zero. This confirms that the pressure has bled down and that it is safe to continue.

MISE EN GARDE!

Ceci est un risque de sécurité à haute pression . L'air comprimé (CDA) offre pression dépasse normalement 100 psig (7 kg / cm²) . Après arrêt de l'externe fournir vanne , vérifier les régulateurs de pression internes sur le panneau de CDA , figure 20 , afin d'assurer qu'ils lisent zéro. Cela confirme que la pression a saigné vers le bas et qu'il est sûr de continuer .

Internal disconnects

If you need to disconnect a specific assembly from line power to prevent it from starting when power is restored, unplug it from the Power Distribution Panel, [Figure 19](#).

Technical Specifications

Performance Specifications	
Analysis Method	Continuous scan FT-IR analyzer
(FT-IR = Fourier transform infrared) Gas Cell Path	5.0 m path length
Gases Monitored	Organic, PFC, CFC, HFC, Metal Organic, NF3 and a wide variety of other inorganic gases
Lower Detection Limit	0.1 to 2.0 ppm for 5.0 m path cell, gas dependent
Scanning Rate	15 sec per point
Sample Point Capacity	Available in 10, 20, 30, and 40 point configurations composite sampling up to 4 points
Data Archiving	30 days for all spectra, 90 days for alarms
Applicable Standards	EN 50270, EN 61010, UL 61010
Installation	Indoor only
Altitude	Up to 2,000 m (6,562 ft.)
Temperature range	5°C to 30°C (41°F to 86°F)
Relative humidity	80% at temperatures up to 31°C (88°F), decreasing linearly to 50% RH at 40°C (104°F)
Main supply voltage	±10% of the nominal voltage
Overvoltage	Category II
Pollution degree	2
Ingress protection	IP 20
Facilities Requirements	
Sample Line Tubing	1/4" ID x 3/8" OD polypropylene
Sample Line Inlets	3/8" Swagelok® connector
Electrical Supply	230 VAC, 10 A or 115 VAC, 20 A
Purge Gas, N2	5 - 10 psi, 10 l/min
Venturi Requirements	90 - 120 psi, 320 l/min
Exhaust Pipe	1.5" NPT
Overall Dimensions	66 x 34 x 25 inches (HxWxD) 1,676 x 864 x 635 mm (HxWxD)
Weight	
Operating	349 kgs / 770 lbs
Shipping	470 kgs / 1036 lbs
Standard Outputs and Communications	
Relay Outputs contacts	80 x DPDT (double-pole double-throw), programmable by sample point and gas type
max. ratings	30 VDC, 2 A

Interfaces	Web based user interface (e-Diagnostics) Ethernet: HTML viewing / control; ODBC access Touchscreen user friendly interface (point and click)
Optional Outputs and Communications via Gateways	
Interface	LonWorks®, Allen Bradley®, Modbus®, Profibus®, OPC drivers others on request
Options and Accessories	
Automatic sample line leak test	user settable

Maintenance

Lockout / Tagout Procedure

ACM 150

Before accessing, testing, touching or removing any electrical circuits, plates or shields in the ACM 150 monitor, disconnect the power following the procedure in [Planned shutdown](#) for both line power and utility gases. The Main Power Switch, [Figure 24](#), is lockable in the Off position, and it provides Lockout / Tagout for the ACM 150 monitor. It disconnects all electrical power within the system.

DANGER!

Electrocution danger. The Main Power Switch is the tie point for line power, which connects to terminals inside the switch. Before removing the cover to this switch to access these terminals, disconnect line power via the external Lockout / Tagout switch.

After appropriately locking and tagging the switch, verify with a voltmeter or equivalent suitable device that all electrical voltage into the ACM 150 monitor has been isolated and de-energized. This procedure should be followed for both the integral Lockout / Tagout switch and any external disconnects that the user may have.

DANGER!

Dangers d'électrocution . L' interrupteur d'alimentation principal est le point de puissance de la ligne de partage des voix, qui se connecte à bornes à l'intérieur du commutateur. Avant de retirer le couvercle ce commutateur pour accéder à ces bornes , la puissance de la ligne de déconnexion via l' externe Lockout commutateur / étiquetage .

Après le verrouillage de manière appropriée et de marquage le commutateur , vérifier avec un voltmètre ou dispositif approprié équivalent que tout tension électrique dans le moniteur ACM 150 a été isolé et DE- tension. Cette procédure doit être suivie pour à la fois le verrouillage intégrante / commutateur Tagout toute déconnecte externes que le utilisateur peut avoir .

External

A means of disconnecting line power at the source is necessary to allow safe access to the power terminals at the ACM 150 monitor. An external Lockout / Tagout switch must be installed for this purpose. Follow your company's Lockout / Tagout procedure, shutting off and locking this switch when required.

Decontamination / Decommissioning Procedures

Purpose

To establish a safe procedure for decontamination and the eventual decommissioning of the ACM 150 monitor at a customers' site.

Procedures



Wear appropriate Personal protective Equipment. Standard Nitrile gloves are recommended.

1. Disconnect all gas sample lines from the fittings on the top of the ACM 150 monitor.
2. Allow the ACM 150 monitor to run in automatic sampling mode for 60 minutes to purge any residual gases in the system. The automatic mode should include the sample ports enabled during normal monitoring operation.
3. Shut off the CDA supply. The backup exhaust pump should automatically turn on. Allow to run for 10 minutes.
4. Shut down the ACM 150 monitor by turning off the power at the power disconnect switch. Lockout and tagout the electrical supply at the facility connection.
5. Shut off the nitrogen supply. Verify that the pressure in both the CDA supply and the nitrogen supply has been relieved. Disconnect both the CDA and nitrogen supply lines.
6. Remove and disconnect all electrical power and communications lines.
7. Remove and replace the sample filter located in the lower pump cabinet. The panels of the lower cabinet are removable for access.
8. Inspect and clean the optics bench components, such as the sample cell, windows and mirrors.
9. If moving the ACM 150 monitor, lock both the sliding optics bench drawer and the pump assembly drawer by installing the appropriate sized screws through the drawer plates and into the lock brackets.
10. Reinstall all outer panels removed during the cleaning procedure and close and latch the outer doors.
11. If decommissioning, please recycle all applicable parts. These might include the steel chassis, circuit boards, etc.
12. Please dispose the decontaminated unit according to all applicable local requirements.

NOTE

The FTIR optics bench will absorb ambient moisture when not powered. Long periods of storage will result in degraded performance of the optics bench and may result in non-operation. Storage of an ACM 150 in high ambient humidity environments is not recommended.

Inspection and service schedule

The ACM 150 monitor constantly monitors itself for proper operation. Problems are identified as Service Events and they change Service Status. At the same time, relays are activated to notify the user of service problems or a loss of power (refer to [Troubleshooting](#)). All users should utilize these relay outputs for immediate notification that a service problem has been detected.

Monthly service

It is highly recommended to reboot the ACM 150 monitor computer monthly. This ensures proper operation and avoids unexpected behaviour.

Quarterly inspection

It is recommended that the ACM 150 monitor be inspected every 3 months (more frequently, if desired) and that service be performed, if any problems or failures are found.

A qualified service technician must be contacted and resolve them following [Service inspections and procedures](#).

Annual PM services

Inspect and service the ACM 150 monitor in accordance with [Service inspections and procedures](#). If you have not already done so during the course of the past 12 months, replace these expendable items:

- Cabinet filters
- Gas cell filter
- In-line filters
- Gas cell windows
- Booster pump diaphragm / flapper valves
- Back-up pump vanes
(but only if the venturi pumps were not in use most of the time)
- FTIR Desiccant

If any of these items have been replaced during the past 12 months and pass inspection, there is no need to replace them during the annual service.

Three year service

These services are recommended at least once every 3 years:

FTIR Optics Bench: The infrared source, HeNe laser and laser power supply have a limited operating life. HA can provide a reconditioned bench to exchange for your used bench, which is returned to HA for reconditioning.

Five year service

These services are recommended at least once every 5 years:



Sample Valves: Disassemble the valve manifolds and clean the valves with a solvent to assure that the accumulation of deposits and particles are removed.

Cycle Valves: These valves are expected to eventually wear out. They can be replaced as one subassembly.

Contract services

Our Service Department offers service contracts to perform on-site scheduled PM services for the ACM 150 monitor, other central monitors and its gas detectors. These contracts can encompass other HA products as well.

ACM 150 service contracts normally include the expendable parts for the annual PM service, and they can also include an FTIR bench exchange. Contact your local HA representative for additional information and a quotation.

ICON KEY	
	Authorized Users
	Trained Technician

Service Operations

Diagnostic mode

NOTE

Proper functioning of the ACM air composition monitor must be verified after all repairs.

Menu selections

Selecting the DIAGNOSTICS key from the ACM 150 monitor touchscreen or from a remote computer pulls up the left column of Diagnostic Menu, shown in [Figure 63](#). This menu offers numerous diagnostic choices, enabling you to evaluate the performance and make adjustments to improve performance.

Selecting the MANUAL MODE OP key pulls up the right column of manual mode selections. In 'Manual Mode Operation' you can test all of the valves and relay outputs.

General access

Diagnostics run in 'Automatic Mode' may be accessed by All Users.

Login access

Diagnostics run in 'Manual Mode' interrupt normal scanning and access special tests. This mode is only available to Authorized Users and Trained Technicians with an assigned Access Code (refer to [Access codes](#)).

NOTE

When you are ready to exit the Diagnostic Mode and return the ACM 150 monitor to normal scan operation, remember to Logout. This prevents unauthorized access to the restricted Setup and Diagnostics menus.

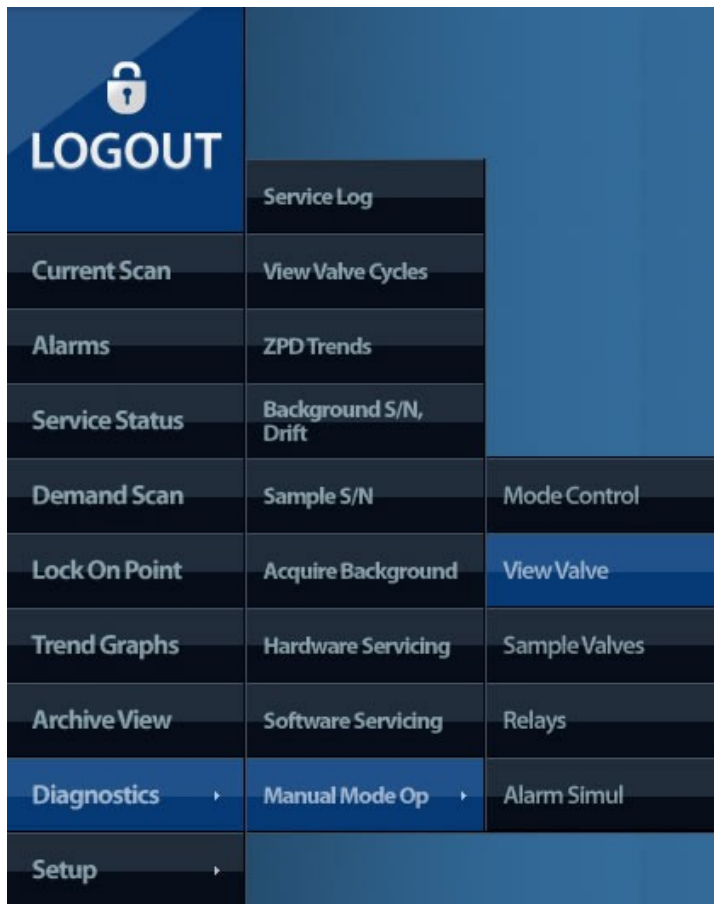

Figure 63. Menu options

Service Log:

This is a list of all the service incident messages stored by the ACM 150 monitor. You can review the time period of interest from the current day to any number of past days.

View Valves Cycles:

Allows you to see which valves are activated during each scan cycle along with the pressure readings as they change.

ZPD Trends:

A diagnostic tool which is useful for evaluating the signal trends of the FTIR analyzer and for identifying problems.

Background, S/N, Drift:

Diagnostic tools which evaluate the performance of the FTIR analyzer and its optical alignment.

Acquire Background:

Not the periodic/automatic background, but an on-demand background scan initiated by the user.

Hardware Servicing:

Only accessed when the ACM 150 monitor is taken out of normal operation for servicing. It access special alignment and test functions.

Software Servicing:

May be used to analyze and control the database on the ACM 150 monitor and is designed for our Fieldservice Engineers.

Manual Mode Op:

When selected, the manual mode menus appear on the right.

Mode Control:

Users with an access code may change the mode from automatic to manual or frontpanel.

View Valve:

Same screen as View Valve Cycles, but the user has manual control over the valve cycling.

Sample Valves:

The port valves 1-40 may be manually controlled in this menu.

Relays:

The 40 programmable relays may be manually activated.

Alarm Simulation:

Allows the user to simulate gas concentrations at the Modbus / TCP interface.

Service log

Reviewing service events

The 'Service log' key pulls up the menu shown in [Figure 64](#). All of the incidents currently stored in memory are displayed starting with the most recent. This list may be limited to a shorter time period, e.g. 1 day or 2 days, by selecting the number of days using the arrow keys and then pressing "Limit List".

These are same incidents listed in the Service Status mode, except you can view incidents that have been cleared and no longer appear in the Service Status mode.

NOTE

To troubleshoot a current problem, refer to [Troubleshooting](#) and follow the instructions provided. Alternately, you can select 'View Instructions' and pull up 'Online Help', which is not currently available.

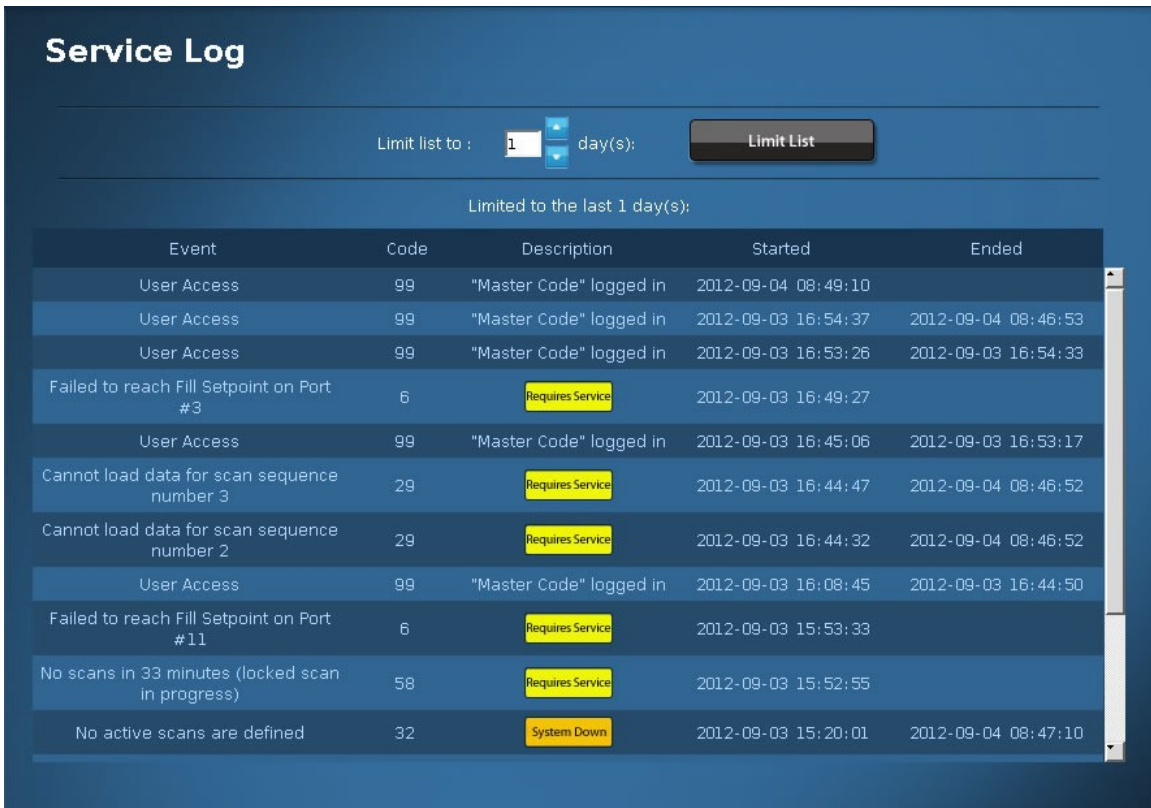

Figure 64. Service log

View valve cycles

This mode displays the ACM 150 monitor flow schematic with the current activation state of each Cycle Valve, as shown in [Figure 65](#).

As the ACM 150 monitor progresses through its sampling sequence, you can observe the changing activate states. The standard activation sequence is explained in [ACM 150 flow cycles](#) and the standard cycle timing and pressures are given in [Table 1](#).



2-way valves shown blank, i.e. with no color fill, are not activated. In this state they are closed and block the flow path.



2-way valves shown with green color fill are activated and open. Sample flow passes through these open valves.



The three graphs indicate the current absolute pressure and the recent trend over time for Sample Cell Vacuum, Bypass Vacuum and Sample Vacuum.

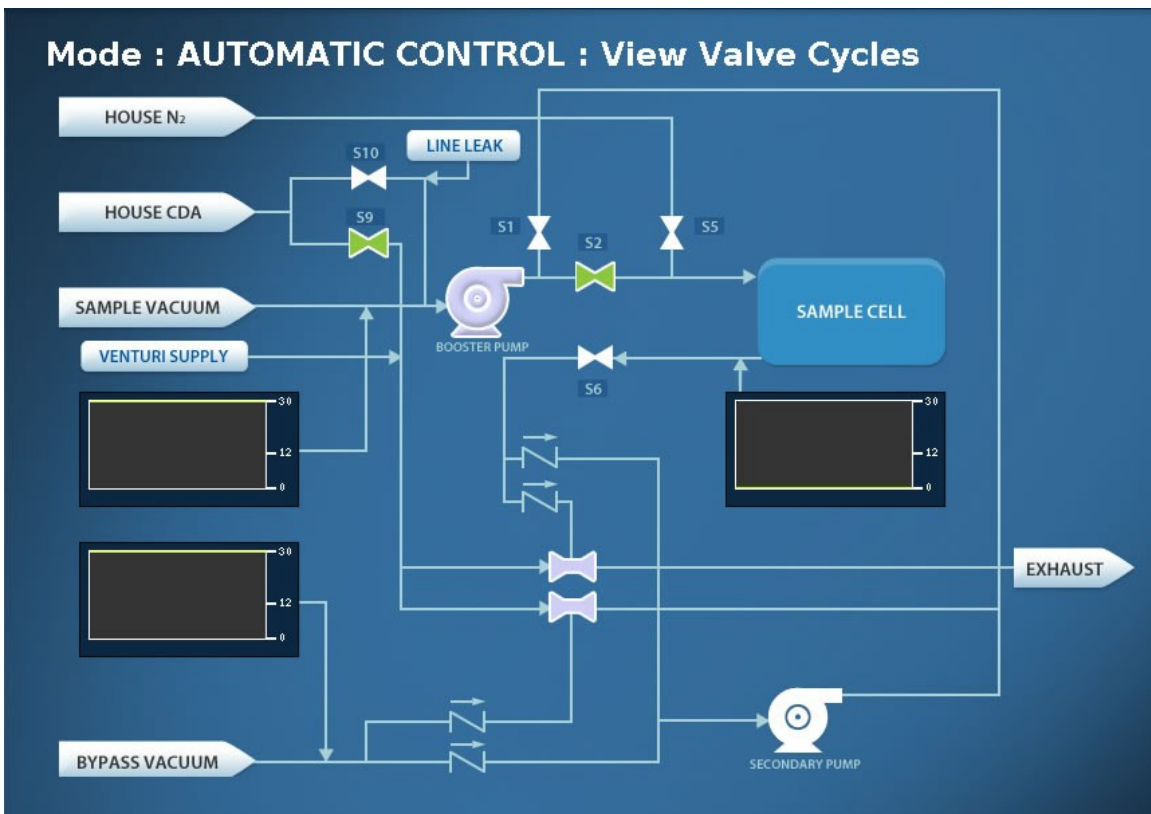

Figure 65. View valve cycles

ZPD trends

The ZPD Trends indicate changes in the FTIR detector signal, which is the relative intensity of the infrared radiation on the detector (refer to [ZPD Value and Location](#) for a complete explanation).

Background ZPD trend

The graph in [Figure 66](#) is a daily average of the ZPD over a 15 day period. It is a trend for the 'Background', which occurs every 2 hours. Because the background gas (nitrogen) is consistent, the graph should be relatively flat.

Between service intervals, the trend is usually in the direction of a decreasing ZPD. A decreasing ZPD is an upward trend on the graph, because ZPD is a negative number. Following a service, where the magnitude of the ZPD increases, or following an upset condition, where the ZPD is reduced, you can expect a 'step-change' in the trend.

Sample point ZPD trends

You can also trend the average daily value of the ZPD for any active sample point. Below the ZPD Trends graph (not shown in [Figure 66](#)) are sample points 1-40. Select one of these points if you want to graph its ZPD Trend.



Figure 66. ZPD trends

Background, S/N and drift

S/N is the signal-to-noise ratio. It is calculated automatically during every 'Background'.

S/N determines the lower detection sensitivity of the FTIR analyzer, the higher the value the better. If the S/N degrades below preset limits, the ACM 150 monitor generates an incident message. A degraded S/N indicates the need for service before it reaches unacceptable levels.

The upper graph in [Figure 67](#), labeled "Background S/N Ratio," shows the average daily S/N and how it drifts over a 15-day period. Ideally, this will be a flat line, however, you should expect a downward trend over time as the S/N degrades between service intervals.

The lower graph, labeled "Background Factory Drift" is also a measure of the S/N and its drift over time, however, it is calculated using the "factory" background spectrum (stored in memory) compared to the current background instead of just the current background spectrum taken every 2 hours.

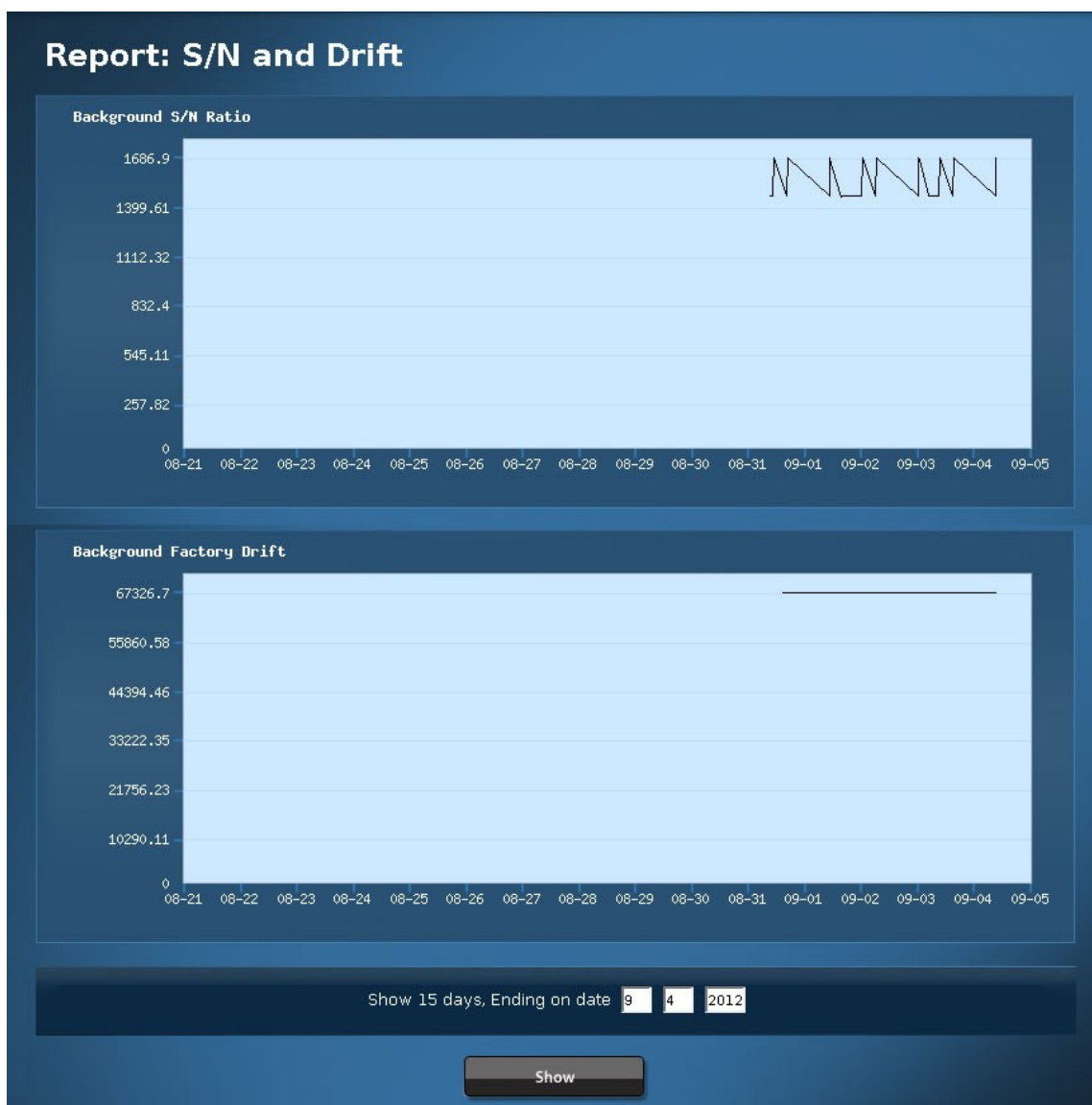

Figure 67. Background, S/N, and drift

Acquire background

You can obtain a background spectrum on demand by selecting 'Acquire Background'. As shown in [Figure 68](#), the background spectrum is displayed for evaluation.

In this mode it is also possible to 'Save New Factory Background' Scan', which would replace the prior reference background.

NOTE

Do not save a new factory background unless you are requested to do so by your HA service technician or application chemist. There should be a valid purpose for updating this reference.

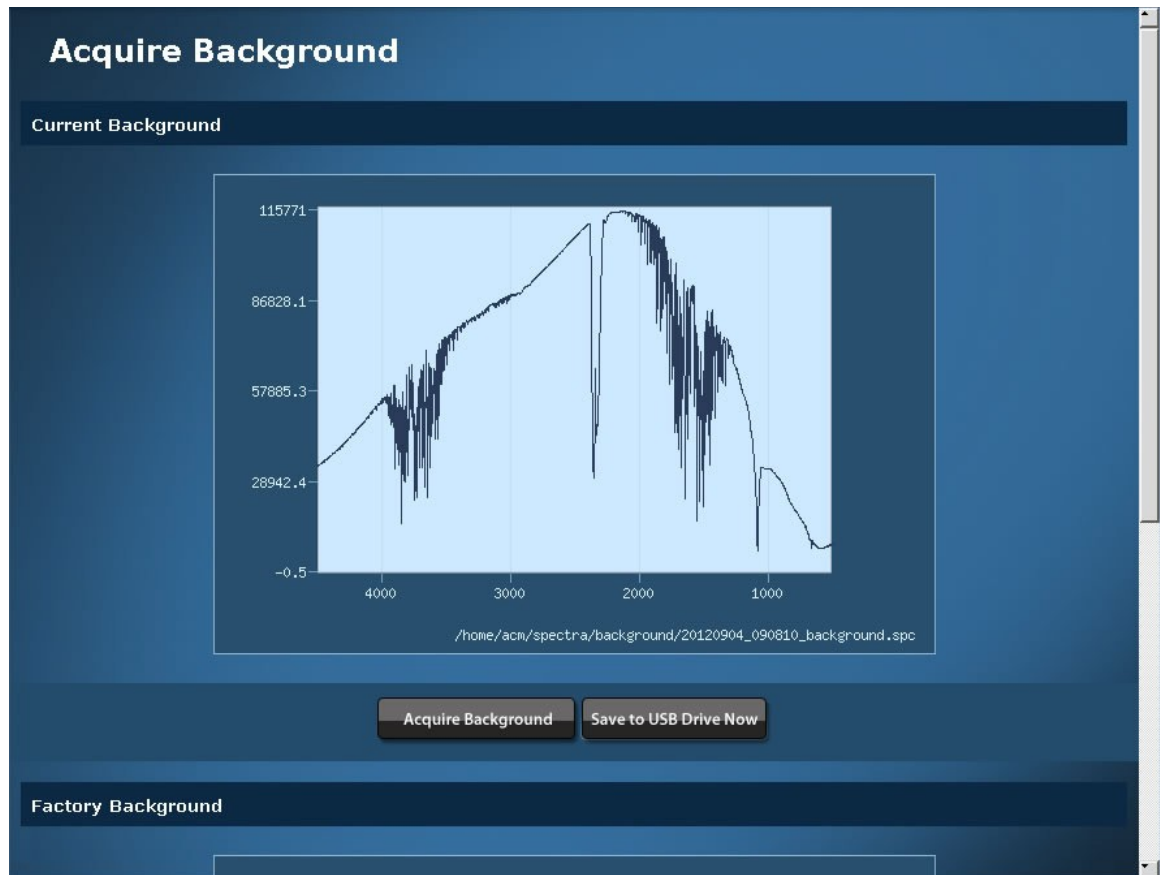

Figure 68. Acquire background

Hardware servicing

The Hardware Service mode requires login access. In this mode you can select any of the following:

Watchdog timer test

If the computer is operating properly the Watchdog Timer (WDT) will always be reset before it reaches the end of its interval and its relay, #82, will not activate. If the computer fails then the WDT will timeout and activate its relay. The test function forces a WDT timeout.

Perform an entire line leak test

Any authorized user can perform this test, provided your ACM 150 is configured for automatic line leak tests. Typically, this test is initiated because one or more line failed its automatic test. If services were performed to resolve the failure, this test verifies successful corrective actions. In this mode you can observe the pressure test of each line as it occurs.

Kinked tube testing

Allows the detection of kinked sample tubes by analyzing the Sample Flow pressure. If a tube is kinked or bent severely and the pressure does not reach the configurable setpoint `KinkedTubeThreshold`, a service event is generated indicating the port and the pressure value. The Kinked Tube Test may be triggered automatically or manually. For automatic triggering, the time of day and the interval may be chosen. For triggering the Kinked Tube Test manually, the user needs to login at the console and press the button “Perform an Entire Kinked Tube Test...” as shown below.

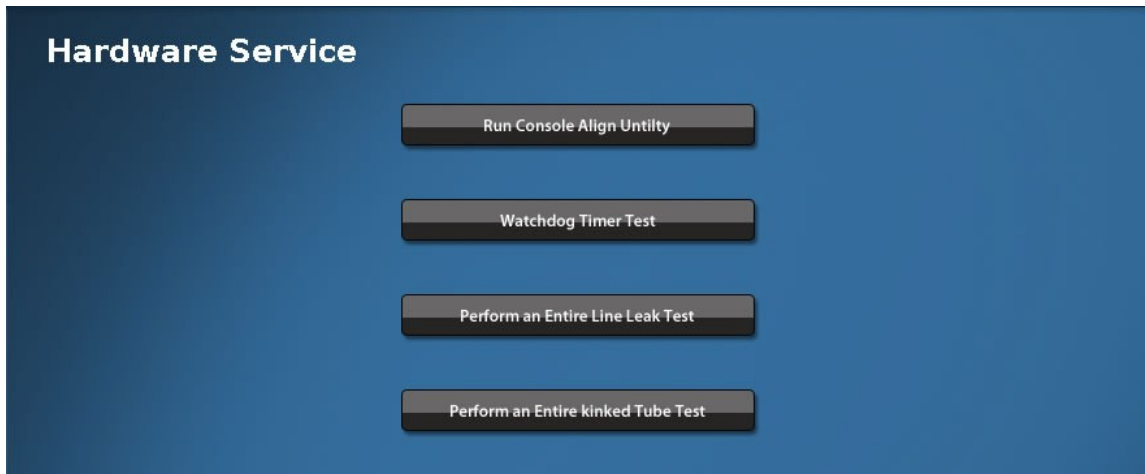

Figure 69. Hardware servicing

Software Servicing***Database Statistics***

The screen “Software Servicing” may be used to analyze and control the database on the ACM 150 monitor and is designed for our Field Service Engineers.

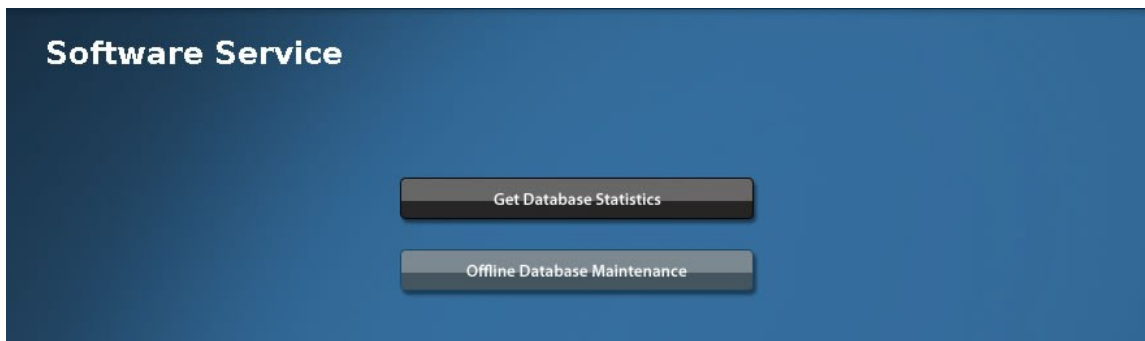

Figure 70. Software Servicing

Clicking “Get Database Statistics” will load a list of key parameters describing the database size and composition. These parameters serve no purpose for the ordinary user and are therefore not explained here.

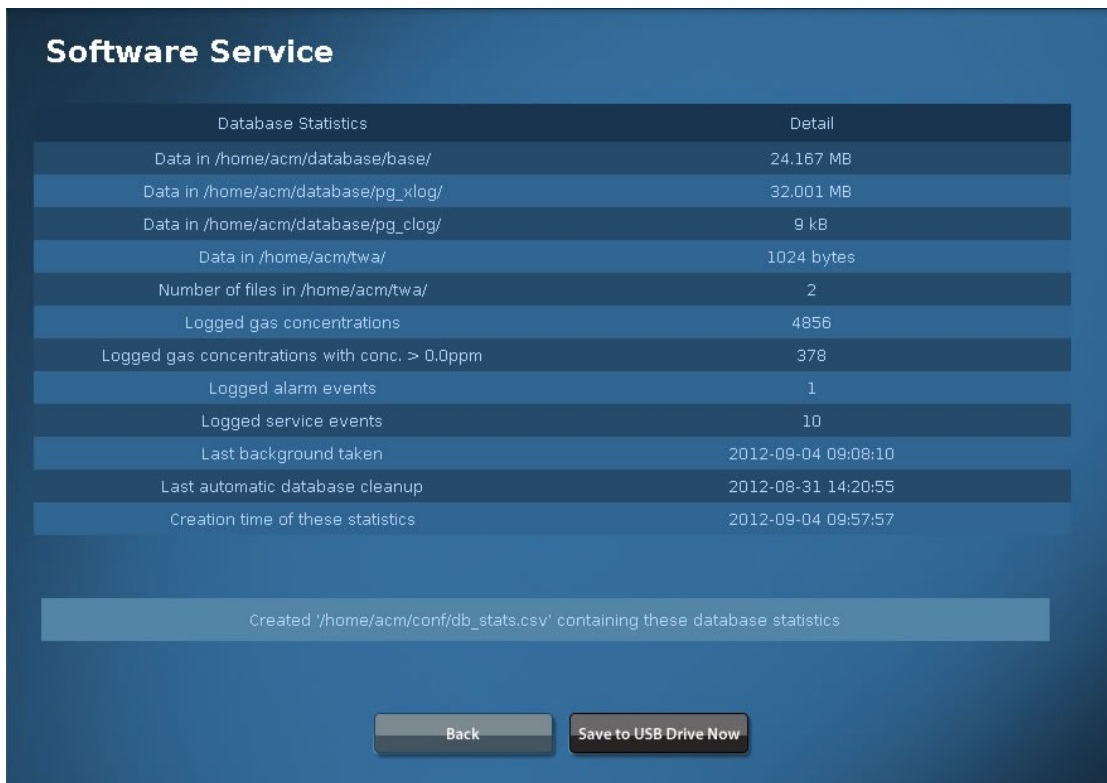

Figure 71. Database Statistics

The same data will additionally be written to the comma-separated text file “db_stats.csv”. You may save this file to a USB stick (or to your Desktop PC if you are operating remotely). Every time the statistics are generated, the complete data is appended to the end of the existing file. Therefore there is no risk of losing old statistical data by clicking this button repeatedly.

Opened with Microsoft Excel, the file will look like this:

	A	B
1	ACM Database Statistics from Customer - SN000	
2	Tuesday 04th of September 2012 09:57:57 AM	
3	Data in /home/acm/database/base/	24.167 MB
4	Data in /home/acm/database/pg_xlog/	32.001 MB
5	Data in /home/acm/database/pg_clog/	9 kB
6	Data in /home/acm/twa/	1024 bytes
7	Number of files in /home/acm/twa/	2
8	Logged gas concentrations	4856
9	Logged gas concentrations with conc. > 0.0ppm	378
10	Logged alarm events	1
11	Logged service events	10
12	Last background taken	2012-09-04 9:08
13	Last automatic database cleanup	2012-08-31 14:20
14	Creation time of these statistics	2012-09-04 9:57
15		

Figure 72. Excel screen

Database Maintenance

As the ACM 150 monitor is normally running in a 24/7 environment, it will pile up huge amounts of data in the database. After several months of operation, this may lead to a slower overall system performance because it takes more and more time to retrieve data from the database. To effectively reduce the database size, the button “Offline Database Maintenance” may be clicked. This password-protected maintenance operation will take less than a minute and will:

- bring the ACM 150 monitor into “Manual Mode”.
- delete all data from the table “Logged Gas Scan Results”.
- put the ACM 150 monitor back into “Automatic Mode”, restarting the normal scan sequence.

CAUTION!

This operation deletes all stored gas concentrations on the ACM 150 monitor. After triggering this, there will be no trend data for the period before the operation. However, there will still be all logged peak and average gas concentrations in the Time-Weighted Average files. This operation will not delete any alarm or service events.

Manual mode operations

As shown in [Figure 63](#), selecting Manual Mode Op expands the Diagnostic menu to access various manual tests. Each test requires login access.

CAUTION!

Placing the ACM150 in Manual Mode or Front Panel Mode will place all flow control in the hands of the operator. If the vacuum pump is operating to provide vacuum, the Operator must ensure that either sufficient flow reaches the pump to prevent overheating, or that the pump is turned off to prevent damage.

Mode control

Mode Control places the ACM 150 monitor into the ‘Manual Control’ mode, as shown in [Figure 73](#). In this mode you have the following options:

1. You can proceed to any of the following 4 test modes and perform the tests either from the ACM 150 monitor touchscreen or from a remote computer.
2. If you are at the ACM 150 monitor, it may be easier to run tests from the local control panels. To do so, select ‘Switch to Frontpanel Mode’ and perform the tests from these control panels:
 - Sample Valve Control Panel (refer to [Sample valve control panel](#))
 - Cycle Valve Control Panel (refer to [Cycle valve control panel](#))
 - Relay Output Control Panel (refer to [Relay output control panel](#))
3. You can exit the Manual Mode by selecting ‘Switch to Automatic Mode’.

When accessing this menu from a remote computer, you can not use or select ‘Switch to Frontpanel Mode’. It has a greyed-out background to indicate that it is inactive.

The Manual Mode is a service mode. The Service Status in the greyed-out status

bar at the top of the display changes to show it is 'Being Serviced' until you exit this mode. The Operating Mode also changes in the greyed-out status bar from Automatic Mode to Manual Mode.

NOTE

While in the Manual Mode, normal point scanning is halted. When you finish the manual testing, switch back to the Automatic Mode to resume point scanning.



Figure 73. Manual control mode

ACM manual control

This mode displays the ACM 150 monitor flow schematic. It is the same schematic displayed in automatic mode, [View valve cycles](#), except you have control over each valve.



When you enter this mode, all valves are inactive. Turn a valve on by selecting the blue circle area.



2-way valves show with green circle fill when they are selected and activated to open. Flow can pass through these open valves. Select the blue square again to close the valve.

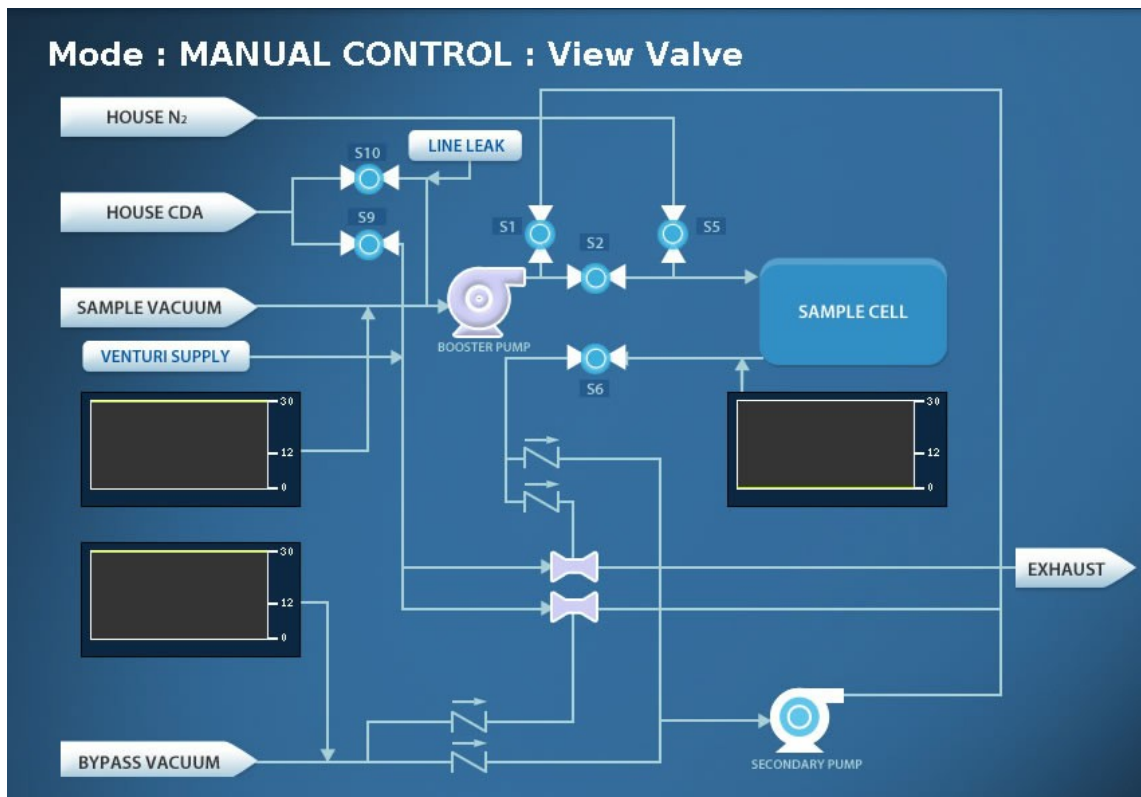

Figure 74. Manual Control - option: Venturi Supply with Line Leak

In the Manual Mode you also have control over the venturi pump and the secondary pump. The venturi pump requires an air supply, which is off in the default mode. Select S9 to open the air supply. Alternately, you can use the secondary pump as a vacuum source in this test mode. The booster pump runs automatically in this mode, it is not subject to manual control.

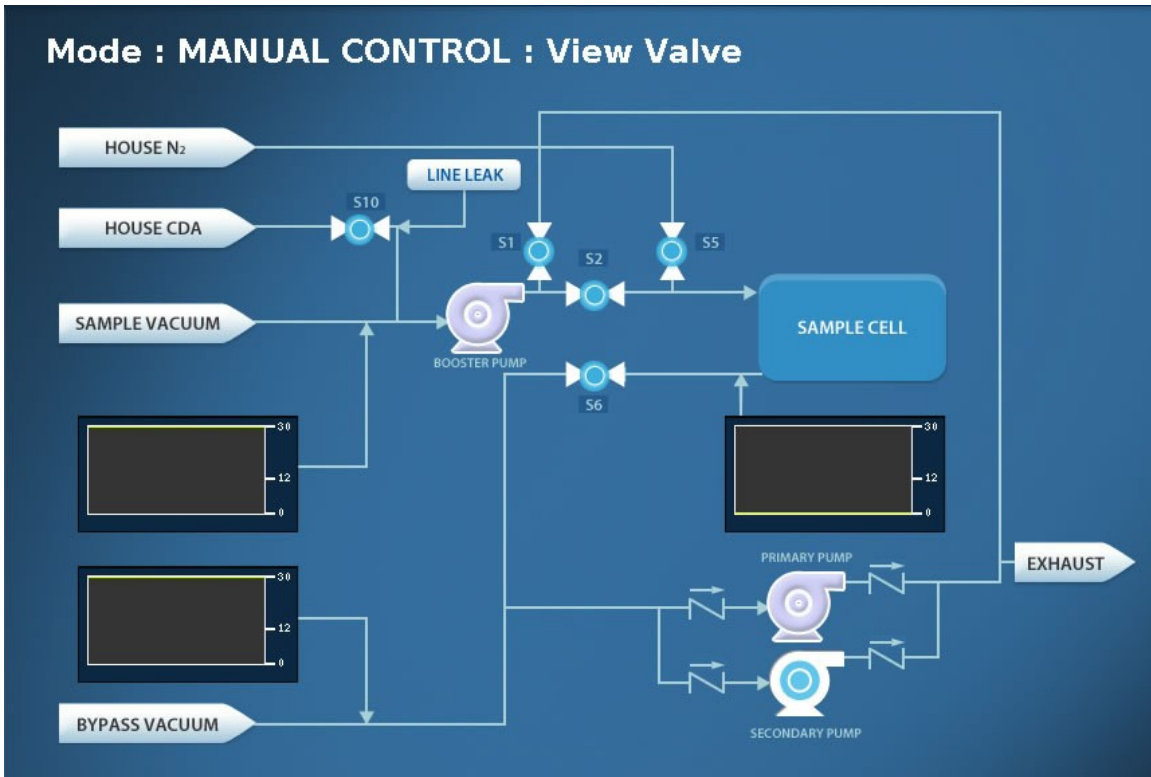

Figure 75. Manual Control - option: Dual Pump with Line Leak

Sample valves

All of the sample valves, 1-40, may be controlled manually. The figure below shows only the first row of the menu, valves 1-10.

No valves are activated when you enter this mode. Select the valve you want to activate to open it. Valves 1 and 6 are selected in the figure shown below. This mode is a convenient way to test any specific sample valve or all valves in sequence.



Figure 76. Sample valves manual control

Relays

All of the output relays may be controlled manually. The ACM 150 monitor has 40 programmable relays. The figure below shows only the first row of the menu, programmable relays 1-10. No relays are activated when you enter this mode. Select the relay you want to activate to open it.

Like the sample valves, the selected relays illuminate in green. This mode allows you to selectively test the relays and the devices wired to them.

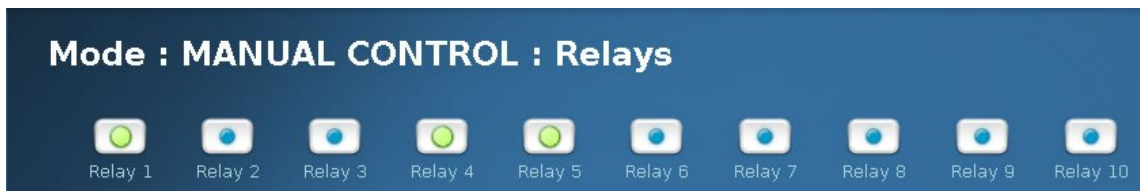

Figure 77. Relays manual control

Service inspections and procedures

Preparation for servicing

Expendable parts on hand

Expendable parts, which are inspected and possibly replaced during PM servicing, should be stocked on-site and available when needed.

Recommended spare parts

To minimize the time for repair, it is recommended that spare parts be stocked by the ACM 150 monitor user. You should review this with your local HA service representative to determine which of these spares should be stocked at your facility to support service. Refer to Sections 10.3 and 10.4 for lists of parts.

Qualified personnel

Services described in this chapter should only be performed by authorized or trained personnel, as defined in [Levels of ACM 150 users](#), and as indicated in the following paragraphs.

Contaminated areas

During normal use, parts of the ACM may contain residual amounts of hazardous materials and service operations may generate contaminated waste. This is especially so for monitors that have been frequently exposed to hazardous material. Examples of service items that may be contaminated are: cleaning materials, gas cells, filters, valves, pump parts, tubing, and ZnSe windows.

Service people should insure that the ACM is safe before attempting repairs. The minimum recommended personal protection includes gloves and safety glasses. It is the user responsibility to dispose of contaminated waste safely and properly.

Servicing the filters

The rate of particulate accumulation varies with the local conditions. Follow the recommended intervals for replacing filters unless your periodic inspections/tests indicate that more frequent replacement is necessary.

Cabinet air filters and fans

Cooling fans are installed in the main cabinet and the lower pump cabinet. Each cooling fan has a filter with a removable plastic cover. These filters should accumulate dust at the same rate. Therefore, they should all be replaced at the same time with the ACM 150 monitor off-line. When replacing filters, wipe dust off the plastic cover. Also, inspect the fans to assure they operate correctly and do not have accumulated dust. Wipe accumulated dust from the fans. Replace fans that do not operate correctly, i.e. do not spin freely.

Internal gas cell filter

The gas cell filter is part of the mechanical pump assembly, [Figure 12](#), located in the lower pump cabinet. Replace it according to the recommended schedule or more frequently if required. The ACM 150 monitor should be taken off-line for this service. If not, expect to generate a Service Status message when temporarily interrupting the sample flow.

If flow through the filter is over-restricted, the pressure during the sampling cycles may be inadequate and create a Service Status message. Follow the test procedure, [Cycle valve tests](#), and replace the filter if the test indicates a flow restriction.

External in-line filters

These filters are located at or near each sample line inlet. Replace filters according to the recommended schedule or more frequently if required. You do not have to take the ACM 150 monitor off-line when replacing filters, because flow is not interrupted.

You can replace all of the filters on the same schedule, or you can replace them in phases, e.g. 25% every three months. Since sample points are often added in phases, you might use the same phase interval for filter replacement. It is time consuming to locate, access and replace the in-line filters.

If flow through one or more filters is over-restricted, the vacuum on those lines should increase when they are sampled and create a Service Status message. Follow the test procedure, [Cycle valve tests](#), and replace the filter if the test indicates a flow restriction.

NOTE

Avoid unnecessary downtime. Do not wait until a Service Status message is generated before replacing filters. Replace filters on an established schedule. You can modify the schedule based on actual experience at your facility.

Visual inspection

You should visually inspect the gas cell filter and in-line filters during each service. The filter housing is white and semi-transparent when new. If the housing appears clean and, if testing indicates there is no flow restriction, you can postpone replacement until the next service.

If the filter appears dark and or deeply discolored, replace it. In-line filters on dirty and/or corrosive sample points appear this way much sooner than filters on clean points. Increase the replacement frequency of filters that foul ahead of schedule. Light discoloring is normal and not a reason to replace the filter before its scheduled replacement date.

Servicing the pumps***Self-monitoring and manual testing***

The ACM 150 monitor constantly monitors its vacuum pumps. If either venturi pump fails to provide adequate vacuum, the Backup Exhaust Pump turns on automatically and a Service Status message notifies the user. A message is also generated if the Boost Pump fails to provide adequate flow, however, there is no backup for the Boost Pump.

During scheduled PM services or following any Service Status messages that might indicate a pump problem, use the manual tests to check the pumps, [Cycle valve tests](#).

Servicing the venturi pumps

The Bypass Venturi and Gas Cell Venturi are shown in [Figure 11](#). There are no scheduled services for the venturi pumps. If testing indicates inadequate vacuum, try increasing the CDA pressure. If that does not restore adequate vacuum, run with the Backup Exhaust Pump and contact HA for service advice.

Servicing the mechanical pumps

The mechanical pumps are shown in [Figure 12](#). The Boost Pump has dual heads, each with a diaphragm and flapper valve that wear out and must be replaced periodically. The parts and instructions are provided in a service kit (Expendable Parts List, Section 10.3). After removing the old diaphragm and flapper valve, wipe the internal metal surfaces to remove particles before the new parts are installed.

The Backup Exhaust Pump is intended to operate infrequently. It should never require service if your venturi pumps operate most of the time. However, if your facility is unable to provide a supply of CDA sufficient to run the venturi pumps, such that the Backup Exhaust Pump is in continuous or frequent use, this pump must be serviced. After it accumulates a total run time of one year, service the pump. Detailed instructions are provided in [Backup vacuum pump](#).

Servicing the valves

Self-Monitoring and Manual Testing

If any solenoid valve fails to switch or open, it will cause a change in absolute pressure or in the infrared spectrum that is sufficient to generate a Service Status message in most cases.

During scheduled PM services or following any Service Status messages that might indicate a sampling problem, use the manual tests to check the valves ([Pneumatic tests](#)).

Servicing the sample valves

The Sample Valves are mounted into 10-port manifolds, as shown in [Figure 5](#). They are not expected to wear out and have no replacement schedule. However, a valve can always fail or develop a problem.

Since the valves mount upside down, there is a possibility that the screws holding the valves to the manifolds might loosen over time. Also, they have an internal orifice that controls and balances the bypass flow. If the orifices plug, they will limit the bypass flow and the response time. The in-line filters stop most particles that can plug the orifices. Sampling without a filter on any point or drawing in dirty, corrosive gases increase the possibility of plugging an orifice. Use the manual checks and tests, [Sample valve tests](#), to identify any problems. Follow the service instructions in [Sample valves](#).

Servicing the cycle valves

The Cycle Valves are the six solenoid valves installed on a removable plate shown in [Figure 9](#). These valves are activated with far greater frequency than the Sample Valves. Expect them to wear out eventually. They should be replaced every five

years, before problems develop in normal use. The valves contacting the sampled gas have Teflon bodies, which are resistant to both corrosion and the absorption of acid gases. Nevertheless, any of these valves can fail in normal use. Use the manual checks and tests, [Cycle valve tests](#), identify any problems. Follow the service instructions in [Cycle valves](#).

Tubing

When you disconnect any internal or external tube fitting from a valve or pump, inspect the end of the tube and the tube fitting. Look for signs of corrosion, particles and/or chemical coating. Replace tubes and fittings that show any of these signs. Also, look for over-tight fittings that compress the tube diameter at the ferrules and create a flow restriction. Replace the fitting and the ferrules.

Inspect internal tubing for any crimps, worn spots and splits, especially around the fittings. Replace defective tubes.

NOTE

Compression tube fittings, e.g. Swagelok fittings, should be turned with a wrench 1/4 turn past finger-tight. Avoid over-tightening the fittings.

Evaluating the FTIR optical path

The modulated infrared beam produced inside the FTIR analyzer (optics bench) passes through windows, reflects off of mirrors and ultimately focuses onto a 2 mm diameter detector. To get the best performance from the ACM 150 monitor, the path through these optics must be clean and clear, and the optics must be in alignment.

Use this procedure to evaluate the condition of the optical path by examining, the ZPD Value, the Signal-to-Noise Ratio and Spectral Balance. After completing these three evaluations, proceed to [Determining the next step](#).

NOTE

These evaluations help determine if it is necessary to inspect and clean the gas cell, adjust the gain and/or align the optics. If they indicate that everything is OK, it can save unnecessary work and downtime.

ZPD value

Follow the instructions in [ZPD trends](#) and look at the trend over the past 15 days. ZPD is a positive number for the Perkin Elmer bench. Typical readings are 50 to 2000. The typical range for the Perkin Elmer ZPD with properly aligned and clean optics is between 75 and 2000 when read in the Background mode, i.e. when the gas cell is filled with nitrogen.

- If the 15 day trend is within the range of 75 and 2000 and if there are no significant changes in the trend, the IR signal is adequate.
- If the 15 day trend is outside these limits and/or if you see a significant change causing a signal degradation in the trend, it fails this evaluation.

NOTE

For more information about the ZPD value refer to [ZPD value and location](#).

Signal-to-noise ratio (S/N)

Follow the instructions in [Background, S/N and drift](#) and look at the trend over the past 15 days of the 'Background S/N Ratio'. Expect S/N to degrade slightly and trend downward over time. If there is a sudden drop in S/N or if the value falls below acceptable limits, it fails this evaluation.

Spectral balance

Follow the instructions in [Acquire background](#). Evaluate the 'spectral balance' of this Background Spectrum by comparing it to the reference diagrams in [Evaluating/resolving spectral balance](#). Verify that the signal intensity at 4000 cm⁻¹ is at least 20% of the signal intensity at 2000 cm⁻¹. Look for any anomalies in the pattern of your Background Spectrum. If the spectral balance is inadequate or if the spectrum shows a dip or other pattern that deviates from normal, it fails this evaluation.

Determining the next step

The next step is determined by the results of the preceding three evaluations, and the choices are:

1. If these evaluations do not fail and if you have no other problems, e.g. related Service Status messages, there is no need to clean the gas cell, and there is no need to adjust the gain or optimize the optical alignment. You can proceed to [Servicing the line leak test](#).
2. If the ACM 150 monitor failed one or more evaluations and/or if you have other problems, e.g. related Service Status messages, proceed to [Servicing the gas cell](#) (unless the problem is a ZPD value that is too high).

Servicing the gas cell***Service objective***

The objective when servicing the gas cell is to correct any conditions which significantly reduce the infrared signal passing through it. The 5 meter long path gas cell also requires clean and clear windows, but it has the added complication of internal mirrors at both ends as well as external mirrors (or "transfer optics"). (The Perkin Elmer bench has all optics sealed away from service personnel.) The external mirrors must be clean and highly reflective. So, conditions which foul the windows should be avoided or controlled in the sample system design.

Lengthening the service interval

In previous generations of the ACM product line, the long path gas cell was mounted vertically. In this orientation, particles and condensable vapors would often accumulate at the bottom of the cell on the internal mirrors and the gas cell windows. The ACM 150 monitor is designed differently with the gas cell in a horizontal orientation. The low point for collecting particles and condensable vapors is the inside of the glass housing, which is not in the infrared path. This design results in less frequent servicing of the gas cell. Also, if you always have in-line filters installed on all of the sample lines, the gas cell filter provides a second stage of filtration. Two-stage filtration minimizes particle accumulation in the gas cell.

Visual check of the gas cell and FTIR optics

With the gas cell in place, visually examine the internal mirrors for any degradation of the highly reflective surfaces, which includes:

- pitting of the mirror surfaces
- flaking-off of the mirror coating
- coating of dust or chemicals
- water spots or a tarnished appearance

Take a flashlight at an angle to check the mirrors more thoroughly. Examine the pair of ZnSe windows for the same general problems. If you see any of these problems, the gas cell should be removed and cleaned and the windows replaced.

You may not be able to see a chemical coating that absorbs infrared radiation and lowers the throughput and, subsequently, the infrared signal at the detector. Perhaps the signal is adequate but the noise may be too high, resulting in a poor S/N. Try cleaning the gas cell and replacing the windows. Replace the gas cell if cleaning it does not resolve the problem.

Check the transfer optics (gas cell's external mirrors) for dust accumulation or tarnishing of the mirror finish. If you find dusty or tarnished mirrors, then also inspect the external mirrors and window on the FTIR optics bench. These mirrors can be cleaned.

Replacing the gas cell

Try cleaning the gas cell to remove dust, spots or chemical coating. If cleaning does not correct the condition or if you see that the mirror coating is pitting, tarnished or flaking-off, replace the gas cell.

Servicing the line leak test

This applies only if your ACM 150 utilizes the optional Line Leak Test. There are no scheduled services. This daily test will generate a Service Status message and identify any sample point(s) failing the test. If you experience any failures, isolate and correct the problem following [Line leak tests \(optional\)](#).

Servicing the Desiccant Module

Check the service procedure document for details.

The desiccant module protects the bench from the effects of humidity and helps to keep the internal optics of the bench warm. The desiccant module has an indicator that has 4 numbers (20, 30, 40, 50) printed on a blue background. The color of the background turns to white when the humidity inside the bench exceeds the level indicated by the numbers. Replace the desiccant module every 12 months or when indicator exceeds 30%.

Manual tests and evaluations

Pneumatic tests

The pneumatic tests identify problems with the sampling system, including the pumps, valves, filters and tube fittings. Problems identified include:

- interruption of sample flow
- restriction of sample flow
- cross-stream leaks
- outside air leaks

Cycle valve tests

If you are at the monitor, refer to [Cycle valve control panel](#), or if you are at a remote location, refer to [View valve cycles](#). Observe the readings from the gas cell pressure transducer ('sample pressure' or 'sample cell') as the ACM 150 monitor scans through all of its active points.

If you are using the long path gas cell, you should see the pressure changing in accordance with (or readings you have recorded for your specific monitor). Identify problems as follows:

- **Fails to Draw a Vacuum:** This indicates that either the Gas Cell Venturi Pump or the Back-up Exhaust Pump (if used) is not drawing a vacuum and needs servicing or that valve S6 is failing to open, S2 is stuck open or leaking or a leak has developed in the gas cell or its connections.
- **Draws Vacuum but Vacuum Remains - All Points:** If the pressure fails to rise during the Surge or Fill cycles all of the time, S6 is stuck open or leaking, S2 is failing to open or the Boost Pump has failed.
- **Draws Vacuum but Vacuum Remains - Specific Sample Point:** If the pressure fails to rise during the Surge or Fill cycles for any specific sample point, the valve for that point is failing to open.
- **Slowly Returns to 0 During Fill Cycle - Specific Sample Point:** This indicates a flow restriction. Most likely, the in-line filter on that point needs to be replaced. To make sure the problem is not inside the ACM 150 monitor, disconnect the sample tube(s) from the problem point(s). If you observe that the Fill Cycle goes to 0 psig in 1-2 seconds with the line disconnected, assume the restriction is at the in-line filter or the sample tubing (or the check valve if the line leak option is used). If disconnecting the tube makes no difference, the flow restriction is in the sample valve for that point or in one of the 10-port manifolds.
- **Slowly Returns to 0 During Fill Cycle - All Points:** This indicates an internal flow restriction. The gas cell filter needs changing or the Boost Pump needs servicing.

To confirm problems with the Cycle Valves, test the valves using ACM Manual Control, [Figure 73](#), via the computer or use the Frontpanel Mode. Selectively turn valves on and off observing the changes to the gas cell pressure readings. Service cycle valves following [Servicing the cycle valves](#).

NOTE

The ACM 150 monitor's valve cycle timing can be changed using the configuration file. This file is to be accessed and modified only by HA, its agent company or the user's Authorized Service Technicians, who have been trained or are following the instructions of HA or its agent company.

Sample valve tests

Verify that vacuum is present by observing the Sample Vacuum and the Bypass Vacuum readings from the respective pressure transducers. At the monitor, you can observe the vacuum LEDs, [Figure 7](#), or from a remote location, observe the readings using View Valve Cycles, [Figure 61](#).

Continue to observe the Sample Vacuum as the ACM 150 monitor scans through all of its active points. Minor fluctuations from one point to the next are normal. If you notice a significant increase in vacuum above normal at one or more point, suspect a flow restriction. The longest sample tube runs (from the most remote sample areas) may always show a bump in vacuum, which is the 'normal' reading for that point.

The following tests are done at the monitor with the pumps running. Select the Manual Control Mode and the Frontpanel Mode. Utilize the Sample Valve Control Panel, [Figure 7](#), and proceed:

- **Valve Test:** Select one of the points, 1-40. Cycle the valve on and off. When off, you should see a large increase in the Sample Vacuum, returning to normal when switched on. Remote users can perform this test in the Manual Control Mode (see [Figure 73](#)). Identify any valve that fails to cycle properly and service it.
- **Flow Test:** With all of the sample valves off, disconnect the inlet tube fittings and attach a flowmeter to each inlet port (a flowmeter test assembly is available from HA service). Measure the flow rate from point to point and compare the flows to each other and to prior tests.

NOTE

Avoid mixing sample tubes. Before disconnecting all of the tube fittings, make sure that every sample tube is labeled with the correct ACM 150 port number. If not labeled correctly, disconnect one tube at a time and reconnect before moving on.

Points with flows that have changed significantly or are out of the normal range require service as per [Servicing the cycle valves](#). Too low a flow indicates a restricted flow control orifice in the valve or a loose valve that is leaking in room air (service the valve). Too high a flow rate indicates that the valve is leaking across its seat or that the bypass orifice is allowing excess flow (replace the valve).

Line leak tests (optional)

If you are using the Line Leak Test, refer [Hardware servicing](#) and select 'Perform an Entire Line Leak Test'. Every point that is currently scanned ([Programmable relays](#)) is included in the test. The Line Leak LED on the Sample Valve Control Panel ([Figure 7](#)) lights while the test is running. The test starts with point 1 and progresses in sequence, skipping any points not in the Order of Scan, until the last point is tested.

You can observe the pressure as the valves switch from point to point. The line pressure should start low and build up for each line as it is pressurized.

Points either pass or fail the test. In order to pass, a pressure has to build up in the sample line that is sufficient to exceed the set point of the sample pressure transducer. If one or more line fails the leak test, go to the ACM 150 monitor to identify the problem, as follows:

- **Leak at Fittings:** Verify that the fittings on both ends of the sample tube are tight (i.e. can not be loosened by hand). Start with the connection port on top of the ACM 150 monitor. Then inspect the fitting that connects to the check valve at the opposite end (inlet) of the tube. If both fittings are tight the check valve may be failing to hold pressure (go to next step) or, less likely, the sample tubing has a leak.
- **Check Valve Leak:** The line can only pass if its check valve shuts off when pressurized during this test. Particles accumulating in a check valve may prevent it from sealing. Resolve this by disassembling and cleaning the check valve. At the same time, inspect the in-line filter and replace it, if necessary. Check the tubing if you can not correct the leak.
- **Tubing Leak:** Verify this by removing the fitting from the check valve inlet and capping it off. Then, run the leak test and observe. If the tube fails to hold pressure, look for a cut or a hole. Replace damaged tubing and make changes to prevent a repeat of the same problem.
- **Setup Problem:** check the setup ([Line leak test setup procedure](#)) and correct any problems.

Evaluating/Resolving the ZPD Location

If the ZPD range is not within tolerance, determine the following:

1. Is the BenchType variable in the acm.cnf set correctly?
Check the acm.cnf and make sure that all of the numbers are set correctly for the bench type.
2. Bench resolution in the acm.cnf should be set to 4 cm⁻¹
For the Perkin Elmer bench, you will find the “BenchResolution = 4.0” in the acm.cnf.
3. Is the FTIR bench running normally?
The Perkin Elmer bench status can be read from the AcmAdapter Log files.
4. Has the ACM 150 monitor been sending out Service Status messages, such as:
 - ZPD location out of range
 - Failure to get interferogram

Try correcting the problem by turning the optics bench power switch off. Wait 10 minutes. Re-power it, wait one minute and observe the new ZPD location. If it resets to within tolerance, the problem is resolved.

For the Perkin Elmer bench, start up the Perkin Elmer software and perform diagnostics. If the problem remains, contact Honeywell Analytics for service assistance.

Evaluating/resolving spectral balance

You evaluate the spectral balance using a Background spectrum. A Background spectrum is provided in “Acquire Background” [Figure 68](#). It should look like [Figure 78](#), having the same overall shape and peaks.

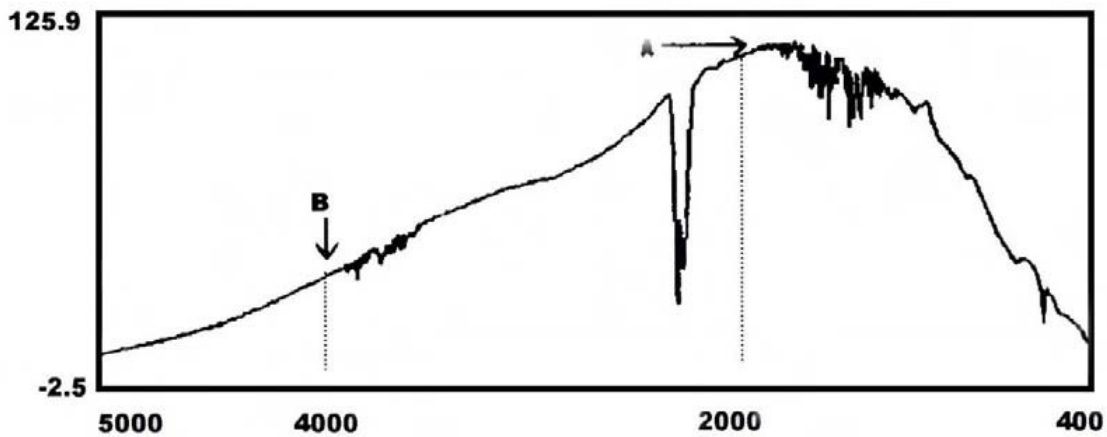

Figure 78. Correct background spectrum

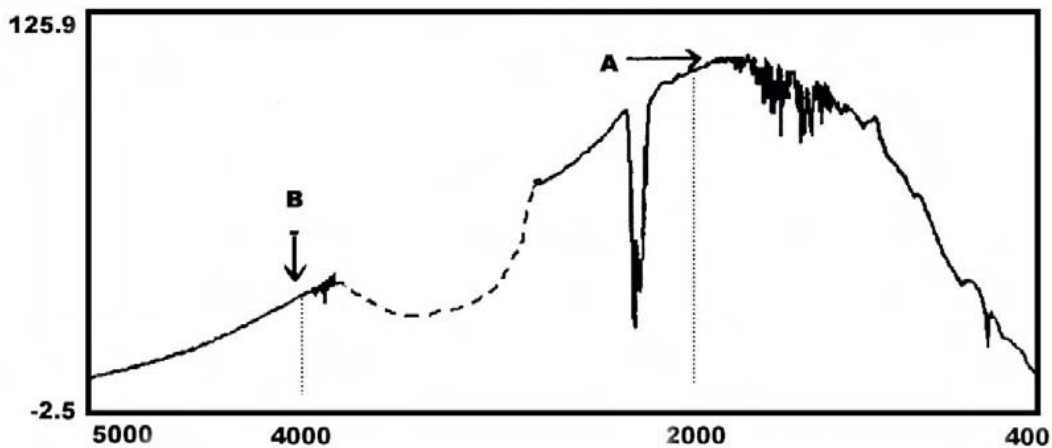

Figure 79. Problem Background Spectrum

1. Compare your Background spectrum to the spectrum shown in [Figure 78](#). Note the intensity of region A (2000 cm^{-1}) and region B (4000 cm^{-1})
2. The intensity at region B should be at least 20% of the intensity at region A. If it is 20% or higher, the spectrum is balanced. If less than 20%, the spectrum is imbalanced and it has an inadequate S/N in region B. This is resolved by cleaning (or replacing) the gas cell and/or by improving alignment.
3. Follow the instructions in [Servicing the gas cell](#).

4. The spectrum in [Figure 79](#) has a dip in the region around 3000 to 3500cm⁻¹. This indicates that there is a chemical coating on the gas cell. It needs to be cleaned or replaced.
5. The ratio of energies at 5000cm⁻¹ and 2500cm⁻¹ are being evaluated as additional evaluation points for the Spectral Balance operation in the future. There is less absorbance due to water in the air at 5000cm⁻¹ and 2500cm⁻¹, and Honeywell expects a throughput of at least 20%. However, at this time have no expected throughput data for the Spectral Balance for the 5000::2500 ratio at this time.

Service and setup instructions

Solenoid valves

Sample valves

To service the valves, remove one 10-port manifold at a time. First, disconnect the inlet tube fittings, [Figure 6](#), and remove the pair of screws at each end. Use the handles to lift the manifold up and out. Lay it on its side. Disconnect the tube fittings that connect to the two manifold headers and unplug the electrical connector.

The header tube fittings and connector are shown in [Figure 5](#). Move each manifold to a work area.

Follow these procedures to correct problems:

- Valve fails to open: Replace the solenoid body.
- Valve leaks/fails to seal properly: Check for loose screws and tighten them. If no screws are loose, disassemble the valve and clean the metal base. Inspect and clean or replace the o-rings between the metal base and the manifold.
- Orifice is partly or completely plugged: Disassemble the valve and remove the orifice plug on the side. Clear the orifice using compressed air, tweezers or alcohol, as needed and clean all surfaces.
- Any evidence of corrosion: Replace the entire valve.

For valves that are functioning properly and show no flow restriction, use a screwdriver to make sure that the screws securing the valves to their base and to the manifold are all tight (avoid using force to over-tighten the screws).

Cycle valves

Remove the Cycle Valves as a subassembly. First, disconnect the tube fittings connecting these valves to external components. Next, unscrew the electrical connectors. These tube fitting connections and electrical connectors are identified in [Figure 9](#). As you disconnect each tube and connector, verify that it is properly labeled. If not, add an ID label (masking tape marked with a pen makes a good temporary label). Remove the screws connecting the plate and move it to a work area.

Follow these procedures to correct problems:

- Valve fails to open: Replace the entire valve.
- Valve is sticky or leaks/fails to seal properly: Disassemble the valve and clean the valve plunger, seat and ports. The disassembled metal parts may be wiped with alcohol or even washed in warm soapy water. Check the valve to assure that it moves freely in its guide and that the springs have enough flex to hold the plunger closed. Place it back into service. Alternately, you can replace the valve body and reuse the coil if it is working properly.
- Any evidence of corrosion: Replace the entire valve.

NOTE

Bottom screws must be removed from the plate to take out a valve. These valves are disassembled by first removing the coils, then removing the valve guide (housing with plunger inside). If you replace the coil or the entire valve, you will need to install an amp connector on the coil wire lead.

Backup vacuum pump

Turn off the main power switch. You need the service kit for the Gas vacuum pump. If the kit includes instructions with diagrams, do not use them. Instead, refer to [Figure 80](#) and [Table 5](#) and use the following procedure:

1. Let the pump cool until it is no longer too hot to handle.
2. Disconnect the inlet and outlet sample tubes from the pump, noting the location of each tube so that they are reconnected to the correct fitting.
3. Remove the bolts on the pump plate (below the pump).
4. Slide out the pump to the front of the cabinet. Then, lift it and rotate it so that the pump head is facing you with the motor to the rear.

NOTE

Expect a release of carbon dust when this pump is disassembled. If this might create a problem where the ACM 150 monitor is installed, disconnect the power cord and move the pump to an acceptable work area before continuing.

5. Remove the two End Caps and their O-Rings.
6. Remove the 5 bolts on the Muffler Box and tap it lightly with a small hammer to break it loose.
7. Scrape off the Gasket between the Muffler Box and the End Plate.
8. Remove the 6 bolts that hold the End Plate to the Body.
9. Remove the End Plate and the 4 Vanes.
10. Use steel wool to clean dirt and dust made by the old Vanes off of surfaces.
11. Install the 4 new Vanes from the kit so that the beveled end slides into the slots in the same orientation as the old vanes.
12. Hold the End Plate to the Body and install the 6 bolts using a torque sequence.
13. Install a new Gasket from the kit between the End Plate and Muffler Box.
14. Get 5 new Bolt Gaskets from the kit and replace the old ones before bolting the Muffler Box to the End Plate. Screw in the bolts but leave them loose.
15. Using the 2 new O-Rings from the kit screw in and tighten both End Caps. Throw away the Felt Filters in the kit. No filters are used in the ACM 150 monitor pump.
16. Tighten the bolts attaching the Muffler Box to the End Plate.
17. Restore power and restart it while the pump is still pulled out. Assure that you have a strong suction and that there are no irregular noises or other problems.
18. Slide the pump back in place and reconnect the tubes and pump plate bolts.

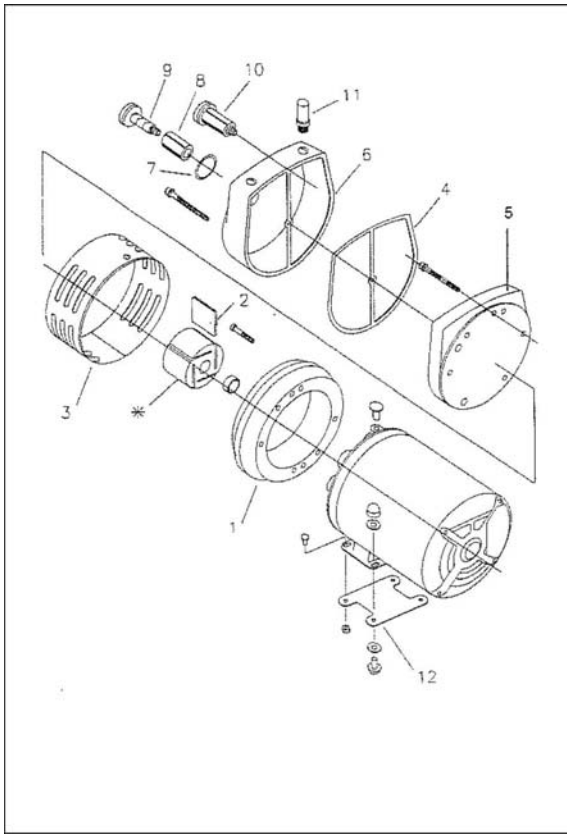

Figure 80. Backup vacuum pump diagram

Table 5. Backup vacuum pump parts list

Item	Service Part	Quantity
1	Body	1
2	Vane*	1
3	Shroud	1
4	End plate	1
5	Gasket*	1
6	Muffler box	1
7	O-Ring*	2
8	Felt* (Do not use)	2
9	End cap	2
10	End cap arm	2
11	Nipple	2
12	Plate bolt	1
	Service Kit	1
	* denotes parts included in Service Kit	

Line leak test setup procedure

These are the procedures recommended to set up the Line Leak Test so that it works correctly:

Prepare for test and setup

Disconnect a few sample tubes at inlet fitting, e.g. points 1 thru 4. Make sure that you have CDA supplied to the ACM 150 monitor and that you have installed check valves at all of the sample point inlets.

Line leak test mode

From the Hardware Servicing menu, [Figure 69](#), select 'Perform an Entire Line Leak Test'. Do the initial setup or check the setup while in this test mode. If the test mode runs to completion before you are done, start it over.

Adjust air regulator

Locate the air regulator on the CDA Panel ([Figure 20](#)). On the initial setup, adjust the air regulator to read 15 psig on its gauge as soon as the Line Leak Test starts (make sure the needle valve is not closed - open it one or two turns, if necessary). Once set up, the air regulator should not require adjustment.

Adjust needle valve



On the initial setup, close the needle valve all the way by turning clockwise. The pressure gauge between the needle valve and S10 should drop to 0. Now, open the needle valve about 1/8 turn or until the pressure reads about 2 or 3 psig. Once set up, the needle valve should not require adjustment.

Pass/Fail

You should observe that the test fails on the open lines (tubes disconnected) and passes on all of the connected lines. It fails because it can not build up adequate pressure on the open lines. However, if you plug off one of these ports with your finger, while it is being tested, it should pass. Observe the pressure gauge between the needle valve and S10 ([Figure 20](#)). On lines that pass, you will see the pressure build up from 0-3 psig to 10-15 psig. On lines that fail, you will see little or no pressure build up.

Configuration problems

You may still run into problems. The Line Leak Test has configurable variables, which are the pass/fail set point (typically 7-10 psig) and the test time per point. If some tubing runs are unusually long, more test time may be needed. HA can change the configuration, if necessary.

ICON KEY	
	Authorized Users
	Trained Technician

Troubleshooting

Identifying problems

Utilizing relay outputs

The ACM 150 monitor computer constantly monitors the operating status of the system. If any problem develops that requires the user's attention, it generates a message identifying the problem. The sooner you are aware of a problem, the sooner you can take actions to resolve it and minimize (or even avoid) downtime. Therefore, it is critical that you utilize the relay outputs that activate under these conditions:

- 81 Power fail
- 82 Watchdog timer (computer problem)
- 83 Manual mode
- 84 General malfunction
- 85 General Alarm 1
- 86 General Alarm 2

NOTE

These relays should be wired to a central control system or alarm panel that is monitored by personnel so that conditions requiring service attention are known as soon as possible.

Utilizing daily inspections

As a backup to monitoring the output relays, a quick daily inspection of the ACM 150 monitor is recommended. It will help you identify problems, and it provides you with an inspection record.

If you are unable to go to the system, you can check the display from a remote location, looking at the Status Bar and Recent Scan mode, and check off the upper part of the form.

Resolving problems

[Table 6](#) lists service messages that might be generated by the ACM 150 monitor software. Troubleshoot the problems by following the recommended actions. Use 'refer to' for guidance, additional information and/or step-by-step procedures.

Table 6. Service request messages

Service Message	Recommended Action	Refer To
Possible line leak problems in line xx	Test the line and its check valve for leaks	<ul style="list-style-type: none"> • Line leak tests (optional)
Possible line leak problems in lines (all)	Check venturi regulator & air supply Check the line leak setup	<ul style="list-style-type: none"> • CDA panel • Line leak test setup procedure
Energy (ZPD) value too low (or too high)	Evaluate the optical path	<ul style="list-style-type: none"> • Evaluating the FTIR optical path
No data from bench	Check the bench for a malfunction Evaluate optical path	<ul style="list-style-type: none"> • Evaluating the FTIR optical path
System stopped	No action required	Stopped at user request
System started	No action required	Stopped at user request
No active scans are defined	Set up an Order of Scan	<ul style="list-style-type: none"> • Order of scan
Cannot establish communication with control boards	Verify that the cables and power cords are connected to the control boards	<ul style="list-style-type: none"> • Interconnecting cables
Cannot update relays	Verify that the cables and power cords are connected to the relay board(s)	<ul style="list-style-type: none"> • Interconnecting cables
Cannot load factory background spectra	Check for missing file or path error (should not occur after initial start-up)	<ul style="list-style-type: none"> • Contact Honeywell Analytics
Energy (ZPD) address out of range or can't determine ZPD	Too little reaching detector	<ul style="list-style-type: none"> • Evaluating the FTIR optical path
Scan cancelled	Normal operation	
Incorrect data length (short/long scan)	Poor connection at FTIR data cable	<ul style="list-style-type: none"> • Evaluating the FTIR optical path
Can not evaluate equation for relay XX	SQL error in relay setup, advanced tab	<ul style="list-style-type: none"> • Virtual relay setup.

Appendix A: KBr MSDS

Trade name: Potassium Bromide

1 Identification of the substance/mixture and of the company/undertaking

Product details

Article number: 09934418

Trade name: Potassium Bromide

Application of the substance / the preparation: Laboratory chemicals

Manufacturer/Supplier:

PerkinElmer Life and Analytical Sciences

710 Bridgeport Avenue

Shelton, Connecticut 06484 USA

Emergency information:

CHEMTREC (within U.S.) 800 424-9300

CHEMTREC (from outside U.S.) 1(703)-572-3887

2 Composition/information on ingredients

Chemical characterization

CAS No. Description: 7758-02-3 potassium bromide

Identification number(s): EINECS Number: 231-830-3

3 Hazards identification

Classification of the substance or mixture

Classification according to Directive 67/548/EEC or Directive 1999/45/EC: Not applicable

Information concerning particular hazards for human and environment: Not applicable

Label elements:

- Labelling according to EU guidelines
- Observe the general safety regulations when handling chemicals.
- The substance is not subject to classification according to the sources of literature known to us.

NFPA ratings (scale 0 - 4)

- Health = 2
- Fire = 0
- Reactivity = 0

HMIS-ratings (scale 0 - 4)

- Health = 2
- Fire = 0
- Reactivity = 0

4 First aid measures

Trade name: Potassium Bromide

General information:

- Seek immediate medical advice.
- No special measures required.

After inhalation: Supply fresh air; consult doctor in case of complaints.

After skin contact: Generally the product does not irritate the skin.

After eye contact: Rinse opened eye for several minutes under running water.

After swallowing: If symptoms persist consult doctor.

5 Firefighting measures

Suitable extinguishing agents:

- CO₂, extinguishing powder or water spray.
- Fight larger fires with water spray or alcohol resistant foam.

Protective equipment: No special measures required.

6 Accidental release measures

Person-related safety precautions:

- Avoid formation of dust.
- Ensure adequate ventilation

Measures for environmental protection: Do not allow to enter sewers/ surface or ground water.

Measures for cleaning/collecting: Pick up mechanically.

Additional information: No dangerous substances are released.

7 Handling and storage

Handling

Information for safe handling: No special measures required.

Information about protection against explosions and fires: No special measures required.

Storage

- Requirements to be met by storerooms and receptacles: No special requirements.
- Information about storage in one common storage facility: Not required.
- Further information about storage conditions:
 - This product is hygroscopic.
 - Store receptacle in a well ventilated area.

8 Exposure controls/personal protection

• Additional information about design of technical systems: No further data; see item 7.

• Components with limit values that require monitoring at the workplace: Not required.

• Additional information: The lists that were valid during the creation were used as basis.

Personal protective equipment

Trade name: Potassium Bromide

General protective and hygienic measures: The usual precautionary measures for handling chemicals should be followed.

Breathing equipment: Not required.

Protection of hands:

- The glove material has to be impermeable and resistant to the product/ the substance/ the preparation.
- Due to missing tests no recommendation to the glove material can be given for the product/ the preparation/ the chemical mixture.
- Selection of the glove material on consideration of the penetration times, rates of diffusion and the degradation

Material of gloves: The selection of the suitable gloves does not only depend on the material, but also on further marks of quality and varies from manufacturer to manufacturer.

Penetration time of glove material: The exact break through time has to be found out by the manufacturer of the protective gloves and has to be observed.

Eye protection: Not required.

9 Physical and chemical properties

General Information

Appearance

- Form: Crystalline powder
- Color: Colorless
- Odor: Odorless

Change in condition

- Melting point/Melting range: Undetermined.
- Boiling point/Boiling range: Undetermined.

Flash point: Not applicable

Flammability (solid, gaseous): Product is not flammable.

Danger of explosion: Product does not present an explosion hazard

Density at 20°C (68°F): 1.4 g/cm³ (11.683 lbs/gal)

Solubility in / Miscibility with

- Water: Soluble

Organic solvents: 0.0 %

10 Stability and reactivity

Thermal decomposition / conditions to be avoided: No decomposition if used according to specifications

Materials to be avoided:

Dangerous reactions No dangerous reactions known

Dangerous products of decomposition: No dangerous decomposition products known

11 Toxicological information

Acute toxicity

Trade name: Potassium Bromide

Primary irritant effect:

- on the skin: No irritant effect
- on the eye: No irritating effect

Sensitization: No sensitizing effects known.

Additional toxicological information: When used and handled according to specifications, the product does not have any harmful effects according to our experience and the information provided to us. The substance is not subject to classification.

12 Ecological information

General notes: Do not allow undiluted product or large quantities of it to reach ground water, water course or sewage system.

13 Disposal considerations

Product:

- Recommendation: Smaller quantities can be disposed of with household waste.

Uncleaned packagings:

- Recommendation: Disposal must be made according to official regulations.

Recommended cleansing agent: Water, if necessary with cleansing agents.

14 Transport information

Land transport ADR/RID (cross-border):

- ADR/RID class: -

Maritime transport IMDG:

- Marine pollutant: No

Transport/Additional information: Not dangerous according to the above specifications.

15 Regulatory information

Sara

- Section 355 (extremely hazardous substances): Substance is not listed.
- Section 313 (Specific toxic chemical listings): Substance is not listed.

Proposition 65

- Chemicals known to cause cancer: Substance is not listed.
- Chemicals known to cause reproductive toxicity for females: Substance is not listed.
- Chemicals known to cause reproductive toxicity for males: Substance is not listed.
- Chemicals known to cause developmental toxicity: Substance is not listed.

Trade name: Potassium Bromide

Carcinogenicity categories

EPA (Environmental Protection Agency): Substance is not listed.

IARC (International Agency for Research on Cancer): Substance is not listed.

NTP (National Toxicology Program): Substance is not listed.

TLV (Threshold Limit Value established by ACGIH): Substance is not listed.

NIOSH-Ca (National Institute for Occupational Safety and Health): Substance is not listed.

OSHA-Ca (Occupational Safety & Health Administration): Substance is not listed.

Product related hazard informations:

- Observe the general safety regulations when handling chemicals.
- The substance is not subject to classification according to the sources of literature known to us.
- Chemical safety assessment A Chemical Safety Assessment has not been carried out.

16 Other information

Disclaimer

The information provided in this Material Safety Data Sheet is based on our present knowledge, and believed to be correct at the date of publication. However, no representation is made concerning its accuracy and completeness. It is intended as guidance only, and is not to be considered a warranty or quality specification. All materials may present unknown hazards, and should be used with caution. Although certain hazards are described, we cannot guarantee that these are the only hazards which exist. PerkinElmer Life and Analytical Sciences shall not be held liable for any damage resulting from handling or from contact with the product.

Department issuing MSDS: Safety and Health Contact:

- With in the USA: 1-(800)-762-4000
- Out side the USA: 1-(203)-712-8488

* Data compared to the previous version altered.

Appendix B: ZnSe MSDS

Trade name: Zinc Selenide

1 Identification of the substance/mixture and of the company/undertaking**Product details**

Trade name: Zinc Selenide

Article number: 09934409B

Application of the substance / the preparation: Laboratory chemicals

Manufacturer/Supplier:

PerkinElmer Life and Analytical Sciences

710 Bridgeport Avenue

Shelton, Connecticut 06484 USA

Emergency information:

CHEMTREC (within U.S.) 800 424-9300

CHEMTREC (from outside U.S.) 1(703)-572-3887

2 Hazards identification

Classification according to Regulation (EC) No 1272/2008:

- GHS06 skull and crossbones
- Acute Tox. 3: H301 Toxic if swallowed.
- Acute Tox. 3: H331 Toxic if inhaled.
- GHS08 health hazard
- STOT RE 2: H373 May cause damage to organs through prolonged or repeated exposure.
- GHS09 environment
- Aquatic Acute 1: H400 Very toxic to aquatic life.
- Aquatic Chronic 1: H410 Very toxic to aquatic life with long lasting effects.

Classification according to Directive 67/548/EEC or Directive 1999/45/EC:

- T Toxic
- R23/25: Toxic by inhalation and if swallowed.
- N Dangerous for the environment
- R50/53: Very toxic to aquatic organisms, may cause long-term adverse effects in the aquatic environment.
- R33: Danger of cumulative effects.

Information concerning particular hazards for human and environment: Not applicable.

Label elements:

- Labelling according to Regulation (EC) No 1272/2008: The substance is classified and labelled according to the CLP regulation.

Hazard pictograms: GHS06, GHS08, GHS09

Signal word: Danger

Trade name: Zinc Selenide

Hazard-determining components of labelling: zinc selenide

Hazard statements:

- H301 Toxic if swallowed.
- H331 Toxic if inhaled.
- H373 May cause damage to organs through prolonged or repeated exposure.
- H410 Very toxic to aquatic life with long lasting effects.

Precautionary statements:

- P260: Do not breathe dust/fume/gas/mist/vapours/spray.
- P261: Avoid breathing dust/fume/gas/mist/vapours/spray.
- P273: Avoid release to the environment.
- P264: Wash thoroughly after handling.
- P270: Do not eat, drink or smoke when using this product.
- P271: Use only outdoors or in a well-ventilated area.
- P301+P310 IF SWALLOWED: Immediately call a POISON CENTER or doctor/physician.
- P321: Specific treatment (see on this label).
- P311: Call a POISON CENTER or doctor/physician.
- P304+P340 IF INHALED: Remove victim to fresh air and keep at rest in a position comfortable for breathing.
- P314: Get medical advice/attention if you feel unwell.
- P330: Rinse mouth.
- P391: Collect spillage.
- P405: Store locked up.
- P403+P233: Store in a well-ventilated place. Keep container tightly closed.
- P501: Dispose of contents/container in accordance with local/regional/national/international regulations.

Other hazards: The product does not contain any organic halogen compounds (AOX), nitrates, heavy metal compounds or formaldehydes.

Results of PBT and vPvB assessment:

- PBT: Not applicable
- vPvB: Not applicable

3 Composition/information on ingredients

Classification of the substance or mixture

CAS No. Description: 1315-09-9 zinc selenide

Identification number(s):

- EINECS Number: 215-259-7
- Index number: 034-002-00-8

4 First aid measures

Trade name: Zinc Selenide

General information:

- Immediately remove any clothing soiled by the product.
- Remove breathing equipment only after contaminated clothing have been completely removed. In case of irregular breathing or respiratory arrest provide artificial respiration.

After inhalation:

- Supply fresh air or oxygen; call for doctor.
- In case of unconsciousness place patient stably in side position for transportation.

After skin contact: Immediately wash with water and soap and rinse thoroughly.

After eye contact: Rinse opened eye for several minutes under running water. Then consult a doctor.

After swallowing: Do not induce vomiting; call for medical help immediately.

Information for doctor:

- Most important symptoms and effects, both acute and delayed No further relevant information available.
- Indication of any immediate medical attention and special treatment needed
- No further relevant information available.

5 Extinguishing media

Suitable extinguishing agents:

- CO₂, powder or water spray.
- Fight larger fires with water spray or alcohol resistant foam.
- Special hazards arising from the substance or mixture: No further relevant information available

Protective equipment: No special measures required.

6 Accidental release measures

Personal precautions, protective equipment and emergency procedures: Not required.

Environmental precautions:

- Inform respective authorities in case of seepage into water course or sewage system.
- Do not allow to enter sewers/ surface or ground water.

Methods and material for containment and cleaning up: Dispose contaminated material as waste according to item 13. Ensure adequate ventilation.

Reference to other sections:

- See Section 7 for information on safe handling.
- See Section 8 for information on personal protection equipment.
- See Section 13 for disposal information.

7 Handling and storage

Handling

Trade name: Zinc Selenide

Precautions for safe handling:

- Thorough dedusting.
- Ensure good ventilation/exhaustion at the workplace. Open and handle receptacle with care.

Information about fire and explosion protection: Keep respiratory protective device available

Storage (conditions for safe storage, including any incompatibilities)

Requirements to be met by storerooms and receptacles: No special requirements.

Information about storage in one common storage facility: Not required.

Further information about storage conditions: Keep container tightly sealed.

Specific end use(s) No further relevant information available.

Additional information about design of technical facilities: No further data; see item 7.

8 Exposure controls/personal protection

1315-09-9 zinc selenide

- WEL:Long-term value: 0.1 mg/m³ as Se

Personal protective equipment

General protective and hygienic measures:

- Keep away from foodstuffs, beverages and feed.
- Immediately remove all soiled and contaminated clothing
- Wash hands before breaks and at the end of work. Store protective clothing separately.

Respiratory protection: In case of brief exposure or low pollution use respiratory filter device. In case of intensive or longer exposure use self-contained respiratory protective device.

Protection of hands:

- Protective gloves
- The glove material has to be impermeable and resistant to the product/ the substance/ the preparation.
- Due to missing tests no recommendation to the glove material can be given for the product/ the preparation/ the chemical mixture.
- Selection of the glove material on consideration of the penetration times, rates of diffusion and the degradation.

Material of gloves: The selection of the suitable gloves does not only depend on the material, but also on further marks of quality and varies from manufacturer to manufacturer.

Penetration time of glove material: The exact break through time has to be found out by the manufacturer of the protective gloves and has to be observed.

Eye protection: Not required

9 Physical and chemical properties

General Information

Trade name: Zinc Selenide

Appearance

- Form: Solid
- Color: Dark brown
- Odor: Characteristic
- Odour threshold: Not determined

pH-value: Not applicable.

Change in condition

- Melting point/Melting range: >1100°C
- Boiling point/Boiling range: Undetermined.

Flash point: Not applicable.

Flammability (solid, gaseous): Product is not flammable.

Ignition temperature:

Decomposition temperature: Not determined.

Self-igniting: Not determined.

Danger of explosion: Product does not present an explosion hazard.

Explosion limits:

- Lower: Not determined.
- Upper: Not determined.

Vapour pressure: Not applicable.

Density at 20°C: 5.42 g/cm³

Relative density: Not determined

Vapour density: Not applicable.

Evaporation rate: Not applicable.

Solubility in / Miscibility with water: Not miscible or difficult to mix.

Segregation coefficient (n-octanol/water): Not determined.

Viscosity Dynamic: Not applicable.

Kinematic: Not applicable.

Organic solvents: 0.0 %

Solids content: 100.0 %

Other information: No further relevant information available.

10 Stability and reactivity

Thermal decomposition / conditions to be avoided: No decomposition if used according to specifications.

Possibility of hazardous reactions No dangerous reactions known.

Conditions to avoid No further relevant information available.

Incompatible materials: No further relevant information available.

Hazardous decomposition products: No dangerous decomposition products known.

11 Toxicological information

Trade name: Zinc Selenide

Acute toxicity

Primary irritant effect:

- on the skin: No irritant effect
- on the eye: No irritating effect

Sensitization: No sensitizing effects known.

Toxicity

Aquatic toxicity: No further relevant information available.

Persistence and degradability No further relevant information available.

Behaviour in environmental systems:

- Bioaccumulative potential No further relevant information available.
- Mobility in soil No further relevant information available.

Ecotoxicological effects:

- Remark: Very toxic for fish
- Additional ecological information:
- General notes:
- Do not allow product to reach ground water, water course or sewage system.
- Danger to drinking water if even small quantities leak into the ground. Also poisonous for fish and plankton in water bodies.
- Very toxic for aquatic organisms

Results of PBT and vPvB assessment

- PBT: Not applicable.
- vPvB: Not applicable.

Other adverse effects No further relevant information available.

12 Disposal considerations

Recommendation: Must not be disposed together with household garbage. Do not allow product to reach sewage system.

Uncleaned packagings:

- Recommendation: Disposal must be made according to official regulations.

Recommended cleansing agent: Water, if necessary with cleansing agents.

13 Transport information

UN-Number

- ADR, IMDG, IATA:UN2811

UN proper shipping name

- ADR: 2811 TOXIC SOLID, ORGANIC, N.O.S., ENVIRONMENTALLY HAZARDOUS
- IMDG, IATA: TOXIC SOLID, ORGANIC, N.O.S.

Transport hazard class(es)

- ADR
- Class: 6.1 (T5) Toxic substances.
- Label: 6.1

Trade name: Zinc Selenide

IMDG, IATA

- Class: 6.1 Toxic substances.

Packing group

- ADR: I

Environmental hazards:

- Marine pollutant: No
- Special marking (ADR): Symbol (fish and tree)

Special precautions for user Warning: Toxic substances.

Danger code (Kemler): 66

Transport in bulk according to Annex II of MARPOL73/78 and the IBC Code: Not applicable.

Transport/Additional information

ADR

- Tunnel restriction code: C/E

UN "Model Regulation": UN2811, TOXIC SOLID, ORGANIC, N.O.S., ENVIRONMENTALLY HAZARDOUS, 6.1, I

14 Safety, health and environmental regulations/legislation specific for the substance or mixture

Labelling according to Regulation (EC) No 1272/2008: The substance is classified and labelled according to the CLP regulation.

Hazard pictograms GHS06, GHS08, GHS09

Signal word Danger

Hazard-determining components of labelling: zinc selenide

Hazard statements:

- H301 Toxic if swallowed.
- H331 Toxic if inhaled.
- H373 May cause damage to organs through prolonged or repeated exposure.
- H410 Very toxic to aquatic life with long lasting effects.

Trade name: Zinc Selenide

Precautionary statements

- P260: Do not breathe dust/fume/gas/mist/vapours/spray.
- P261: Avoid breathing dust/fume/gas/mist/vapours/spray.
- P273: Avoid release to the environment.
- P264: Wash thoroughly after handling.
- P270: Do not eat, drink or smoke when using this product.
- P271: Use only outdoors or in a well-ventilated area.
- P301+P310 IF SWALLOWED: Immediately call a POISON CENTER or doctor/physician.
- P321: Specific treatment (see on this label).
- P311: Call a POISON CENTER or doctor/physician.
- P304+P340 IF INHALED: Remove victim to fresh air and keep at rest in a position comfortable for breathing.
- P314: Get medical advice/attention if you feel unwell.
- P330: Rinse mouth.
- P391: Collect spillage.
- P405: Store locked up.
- P403+P233: Store in a well-ventilated place. Keep container tightly closed.
- P501: Dispose of contents/container in accordance with local/regional/national/international regulations.

Chemical safety assessment: A Chemical Safety Assessment has not been carried out.

15 Other information

Disclaimer

The information provided in this Material Safety Data Sheet is based on our present knowledge, and believed to be correct at the date of publication. However, no representation is made concerning its accuracy and completeness. It is intended as guidance only, and is not to be considered a warranty or quality specification. All materials may present unknown hazards, and should be used with caution. Although certain hazards are described, we cannot guarantee that these are the only hazards which exist. PerkinElmer Life and Analytical Sciences shall not be held liable for any damage resulting from handling or from contact with the product.

Department issuing MSDS: Safety and Health Contact:

- With in the USA: 1-(800)-762-4000
- Out side the USA: 1-(203)-712-8488

* Data compared to the previous version altered.

Appendix C: Glossary

Access Codes

An access code is a 4 number sequence that must be entered for accessing many of the keypad menu selections to prevent unauthorized changes to the scanning program and use of the test functions. A generic code is provided to authorized users by HA. Upon request, HA will add a series of code numbers or change the generic access code. Authorized users can assign a specific code to each employee who requires access to these functions.

EHS

A professional employee, manager or consultant responsible for one or more of the following areas:

- Environmental
- Health
- Safety

ERT

An Emergency Response Team that responds when there is a leak or spill of hazardous production materials (including toxic gases).

FTIR

Fourier transform infrared (FTIR) is the ACM 150 monitor's analysis method. The analyzer collects infrared (IR) absorbance spectra of the air from each sample point. These spectra cover the "fingerprint" or mid-infrared wavelength region. Nearly all chemicals have an IR absorbance spectrum, which is always the same and unique for each chemical. The FTIR spectra have a high resolution which enables the distinct identification of one chemical from the another. The ACM 150 monitor only monitors for chemicals in their gas (vapor) phase.

HA

Honeywell Analytics

LAN

This refers to the HA Local Area Network, which includes a server computer, a network hub and usually one or more remote network computers. The LAN always interfaces to HA monitors. One network can accommodate as many as 32 monitors. The LAN utilizes HA proprietary ERM (Emergency Response Manager) software.

Lockout/Tagout

This is a means of protecting personnel from AC line voltage when accessing or servicing AC terminals or line-powered components. Lockout is a means of disconnecting the line power using a removable key switch, adding a lock over the line power plug or locking a power disconnect box after power is turned off. Tagout is a safety tag that serves notice when a circuit is locked-out.

PSIA

Pounds per square inch absolute, pressure relative to a vacuum.

PSIG

Pounds per square inch gauge, pressure relative to atmospheric pressure at sea level.

PPM

The ACM 150 monitor reports concentration values for gases in parts per million (PPM) and parts per hundred thousand (PPHT) (water vapor only).

A pure gas would have a value of 100% concentration (by volume). One part in one million (1 PPM) is 0.0001% or 100% divided by 1 million. 1 PPHT = 10 PPM. These are the relationships between PPB, PPM and %:

PPM	%
0.01	0.000001
0.1	0.00001
1	0.0001
10	0.001
1,000	0.1
1 million	100.0

TLV

Threshold limit value

TWA

Time-weighted average

ACM 150 Air Composition Monitor
Revision 2, ECO# HAA150063
December 2015
©Honeywell Analytics

Honeywell